

welcome to the backyard...

outdoor kitchen kits collection



No cutting, no guessing, no hassles – no problem®
necessaries™
kits for outdoor living

ROCKWOOD
RETAINING WALLS
A better way.

...you're going to love it out here!

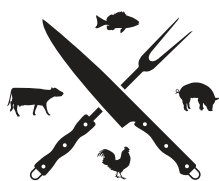

the **kitchen**[™]
by necessities

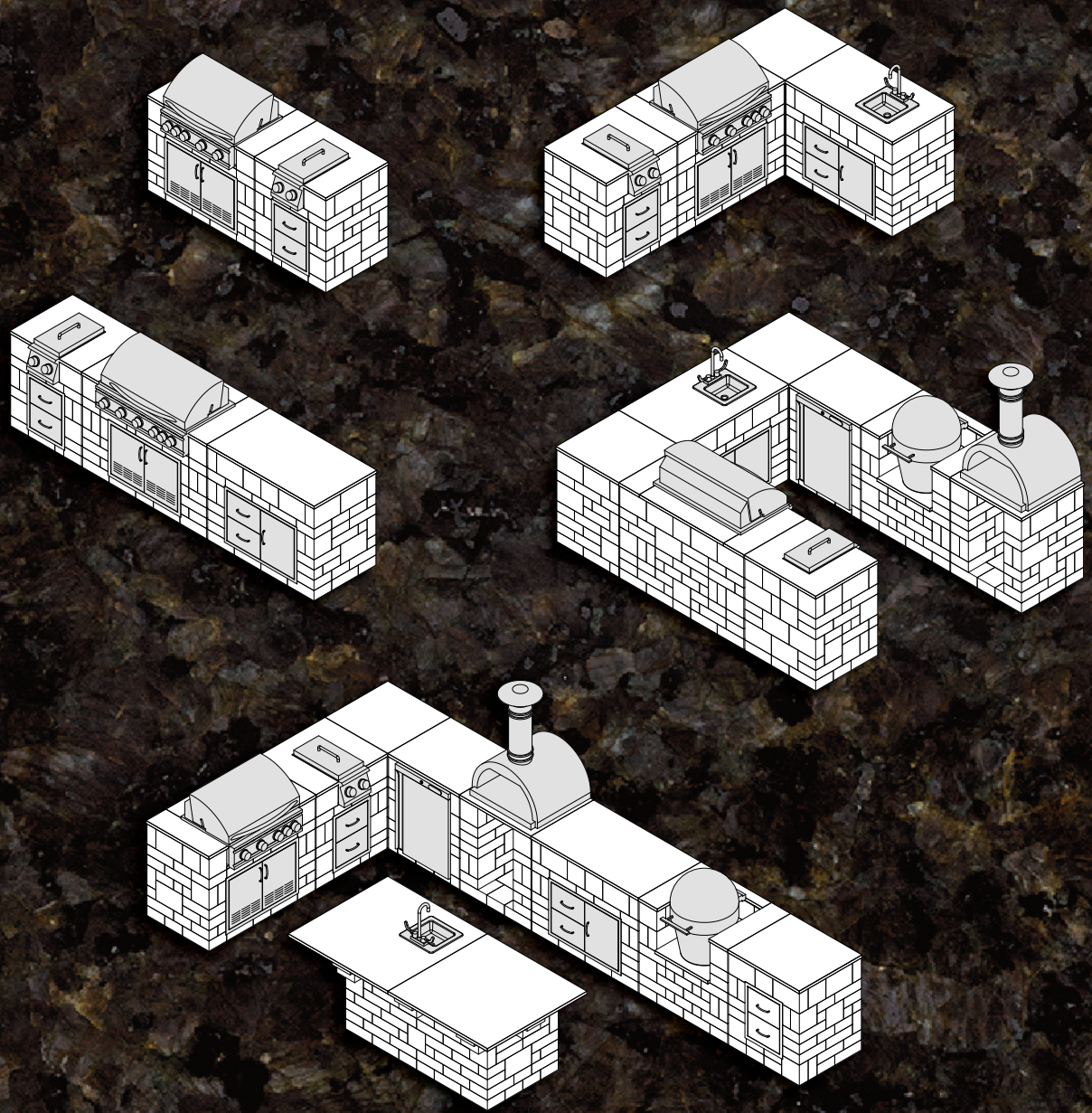

The **kitchen** is a collection of granite-topped cabinet kits for backyard baking, grilling, dining and entertaining.

Elegant, functional and affordable, these quality components and cabinets are ready to assemble in any configuration you can imagine.

Affordable luxury

The Kitchen by Necessaries is beautiful, functional and turns backyards into attractive and enjoyable outdoor living spaces. These cabinets come ready to assemble making them easier to install and more affordable than typical masonry structures.



Easy to build

The Kitchen is a series of individual cabinet kits that come complete with everything needed to build, including precut block and granite tops sized to fit, reinforcements, adhesive, and easy-to-read, step-by-step instructions. Depending on the complexity, most kitchens can be built in a day or less.

Expand at anytime

Build your Kitchen all at once or add new features over time. Because of their modularity, expanding your outdoor cooking and entertaining space is easy to do at any time.

Convenient standard features

- Easy-to-read, step-by-step instructions
- Rockwood's multi-piece tumbled Lakeland block
- Premium stainless steel grills and components
- High-grade 3cm granite tops
- Concrete precut and reinforcements sized to fit
- VOC compliant adhesive and gloves

Earthy colors

The Kitchen features Rockwood Retaining Walls' multi-piece, tumbled Lakeland wall block. Its linear design and aged appearance fit well in landscapes of any style or decor.





Premium grills, ovens and kitchen components

The Kitchen features Summerset Professional Grills and stainless steel components. Their commitment to quality is reflected in the craftsmanship of their products that are backed by the strongest warranty in the industry.



40" Sizzler Grill

Made with crazy good stainless steel

The Kitchen grills and cabinet components are subject to constant use, and the damaging effects of time and Mother Nature. For these reasons, the Kitchen grills and components use high-grade stainless steel for reliability and durability. These professional series grills are designed and built with performance, ease of use and total customer satisfaction in mind. With proper care and maintenance, they can last indefinitely.

The real strength comes from #443 stainless steel. Grade #443 stainless steel is an alloy high in titanium and chromium (making it magnetic), yet very low in carbon. High quality stainless steel was formally perceived as non-magnetic, but since the origin of #443 that is no longer true. Compared to other grades of stainless steel, #443 expands less when heated - meaning less stress, warping and corrosion - making it the choice for use throughout the Summerset Professional Grill Series.

Grade #304 is one of the most widely used grades of stainless steel. Its durability and beauty make it the preferred grade in the market. #304 is a non-magnetic alloy high in chromium and nickel with some carbon. It is used in the drawers, doors and sinks, along with the cooking grids and racks, because it will last like no other.

There are stainless steels you won't find in any of our products

Grades #201 and #202 stainless steel are comprised of nickel with magnesium or nitrogen. These alloys were created to reduce costs; they are not magnetic, nor stand up to the elements as well as grades #304 or #443. Commonly used in grills and appliances of lesser quality, #201 and #202 are more likely to experience corrosion when subject to high temperatures.

And backed by some serious warranties

Grills: Limited Lifetime warranty on construction and manufacturer defects. Limited Lifetime warranty on frame and housing. Limited Lifetime warranty on cooking grates, burners and valves. One year warranty on all other parts, components, and electrical.

Components: Limited lifetime warranty on construction, workmanship and materials for all stainless steel components, including doors, drawers, ice chests, beverage centers, sinks and grill liners.

Granite/Concrete: All Kitchen cabinets come with a limited lifetime warranty on the granite and concrete against material defect.

For complete warranties, visit us online at

www.outdoorlivingkits.com

www.summersetgrills.com



Beautiful granite tops

Granite is an igneous rock formed billions of years ago when magma cooled deep beneath the earth's crust. Nearly as durable as diamond, granite owes its density and hardness to its origins – solidified under extreme pressure deep within the earth.

Granite is as durable as it is beautiful; it's not affected by extremes in temperature and under normal conditions, resists etching by knives, household acids and kitchenware.

Besides its beauty, granite is...

- 100% natural and non-toxic
- Cleans without difficulty
- Sanitary – when sealed, granite does not harbor bacteria
- Highly resistant to burning or charring from hot pans, appliances, utensils etc.

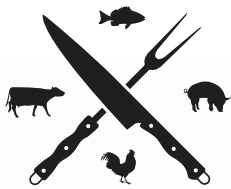

the **kitchen**[™]
by necessities



Viscon White

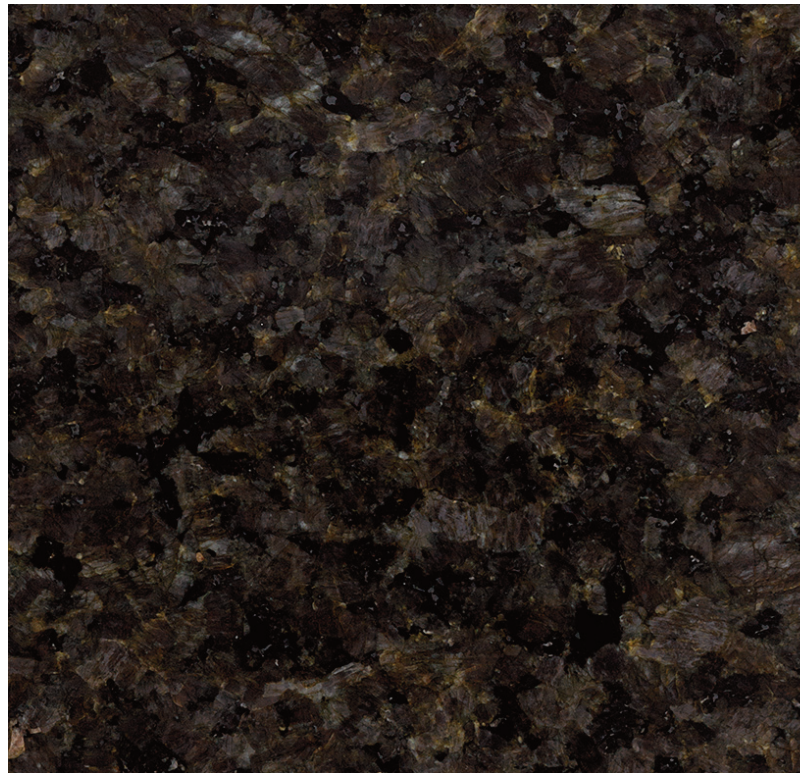

Black Pearl

the **sizzler grill** cabinet

Summerset's Sizzler Grill Series is a premium product at an unbeatable price. Designed with careful precision to ensure optimal airflow and even heating, this grill gives its higher-priced competitors a run for their money in both durability and grilling performance. The Sizzler will impress the most discriminating grillmaster.

Summerset Sizzler Grills (standard)

- #443 stainless steel construction
- Push-to-turn knob ignition, 3" temp gauge
- 12,000 BTU #304 stainless steel burners
- 15,000 BTU infrared back burner
- Natural gas or propane fuel
- Double-lined hood assures optimal airflow
- 8mm cooking grates won't warp or rust
- Easy-clean briquette system for even heat
- 30" double stainless doors
- Choice of granite/cabinet colors

Pro Sizzler Grills (upgrade)*

- + Exterior LED lights
- + 14,000 BTU cast burners
- + Heat zone separators
- + Interior cooking lights
- * Requires 120 volt electrical

The Pro Sizzler features will be appreciated with every use!

Deluxe Rotisserie (optional)

- #304 stainless steel, heavy-duty motor and 25 lb. capacity

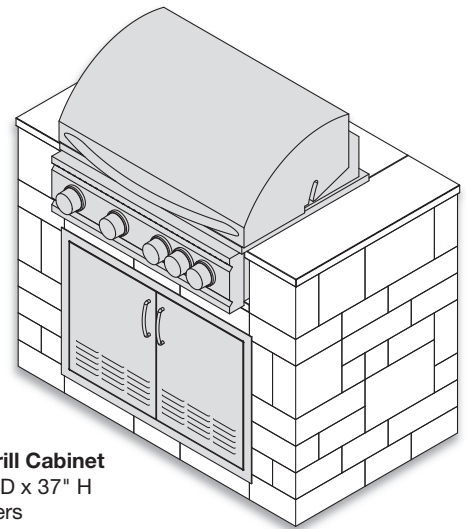

32" Sizzler Grill Cabinet

- 48" W x 28" D x 37" H
- 4 main burners
- 795 sq. in. cooking surface
- Pro Sizzler option

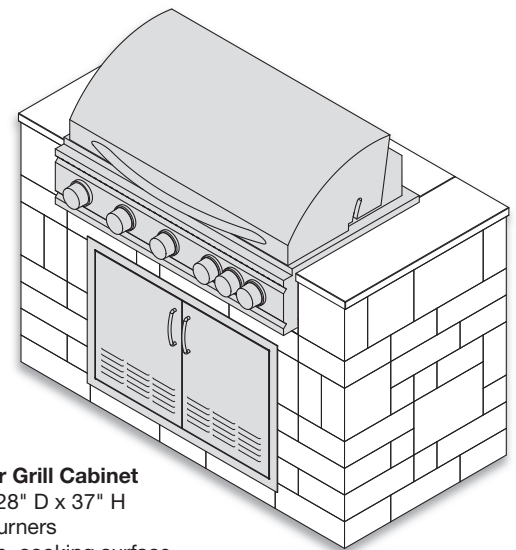

40" Sizzler Grill Cabinet

- 56" W x 28" D x 37" H
- 5 main burners
- 985 sq. in. cooking surface
- Pro Sizzler option





32" Sizzler Grill

Sizzler
Grill

the **outdoor oven** cabinet

This beautiful stand-alone wood-fired outdoor oven is sure to be enjoyed for its ease of use and ability to bake delicious entrees, breads, desserts and pizzas in minutes.

Outdoor Oven (sold separately)*

- 32" W x 30" D x 40" H
- 24" x 24" cooking surface
- Handcrafted in Sicily
- #304 stainless steel construction
- Reinforced, polished stainless steel chimney pipe
- Stainless steel wood caddy
- Stainless steel door
- °C/°F Thermometer
- Color: Hammered copper

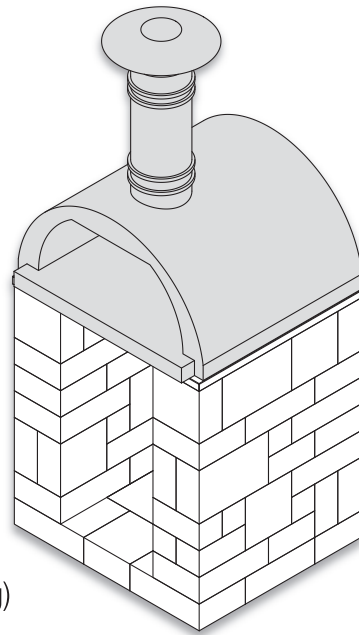

Woodbox/Stand Kit

- 4.75 cu. ft. of storage (16" W x 16" D x 32" H opening)
- Choice of granite/cabinet colors

*Exact style, color and features may vary.







the kitchen™
by necessities





the **island** cabinet

The Island cabinet is the centerpiece of your outdoor kitchen. It's large enough to seat six adults and has over 28 square feet of surface for prep, dining and entertaining. The center storage area comes with two stainless steel drawers and a single door. Available with or without the sink.

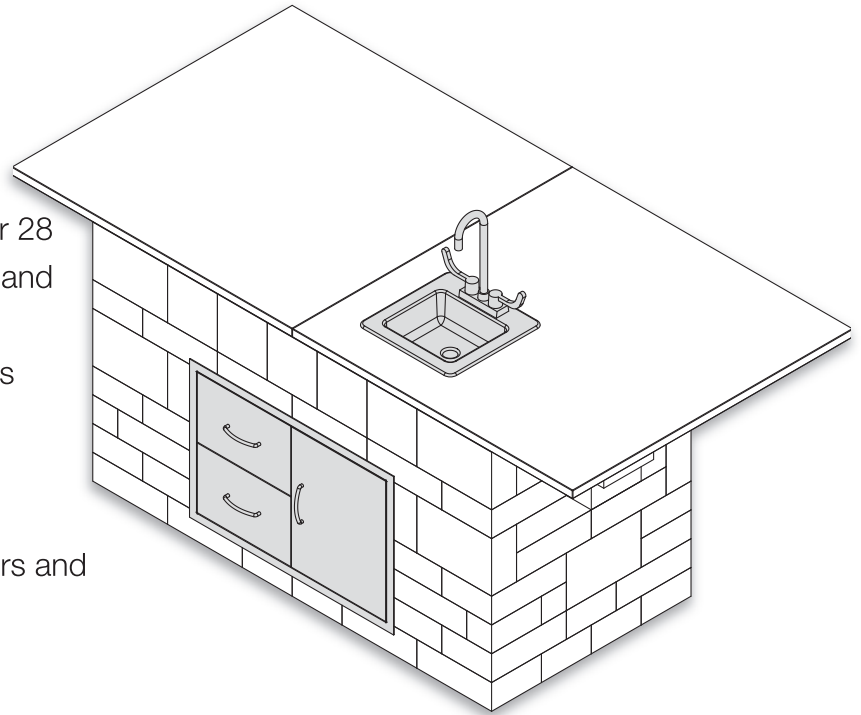

- Two easy-glide stainless steel drawers and magnetic close door
- Choice of granite and cabinet color

Drop in Sink (optional)

- 15" L x 15" W x 6" D basin stainless sink
- Double handle valve stainless faucet
- Stopper/strainer



Kitchen kits come with everything needed to build, including stainless components, precut block, steel reinforcements, construction gloves, adhesive and step-by-step instructions.



Before planning your Kitchen project, check with your local zoning commission for building restrictions and required construction permits. **Always call 811 before you dig.**



the **prep center** cabinet

With over 9 sq. ft. of surface, the Prep Center Cabinet will be appreciated for its generous workspace. Build it with the optional sink, and it will make your outdoor kitchen truly complete.

- Two easy-glide stainless steel drawers and magnetic close door
- Choice of granite/cabinet colors

Drop in Sink (optional)

- 15" L x 15" W x 6" D basin stainless sink
- Double handle valve stainless faucet
- Stopper/strainer

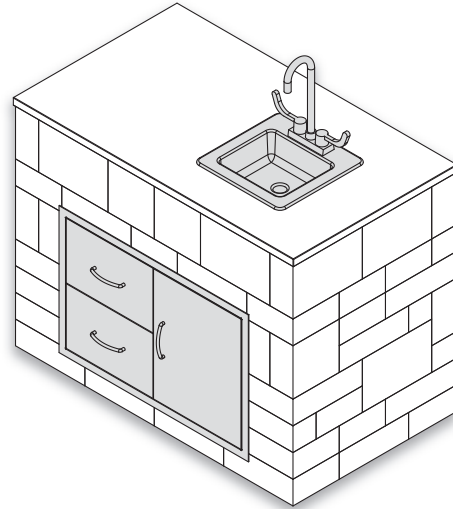

Summerset doors and drawers offer attractive, easy to install flush mounting hardware. Doors feature magnetic latches to keep them closed, secure and orderly.



Kitchen cabinet colors

Kitchen cabinets feature Rockwood Retaining Walls' multi-piece, tumbled Lakeland wall block and are available in colors made by authorized manufacturers. Shown here in Santa Fe.



the **side burner** cabinet

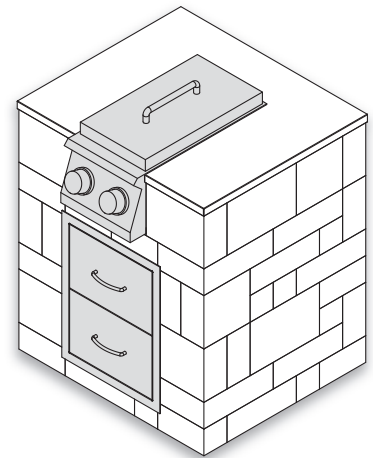

Summerset drawers are completely enclosed to protect against animals and insects.

Combine the comfort of an indoor kitchen range with all the benefits of being outside. Specially designed for performance and function, Summerset's double side burner is the perfect addition to your outdoor kitchen.

- #304 stainless steel construction
- Push-to-turn knob ignition
- Easy-glide, enclosed stainless steel drawers
- 24,000 BTU solid brass burners
- 19.5" x 10.5" cooking surface
- Protective stainless steel cover
- Choice of granite/cabinet colors

the **refrigerator** cabinet



- 24" W x 24" D x 36" H opening
- Choice of granite/cabinet colors

Refrigerator (optional)

- UL certified for outdoor use
- #304 stainless steel construction
- 5.5 cu. ft. capacity
- Reversible door with lock and key
- Digital temperature display

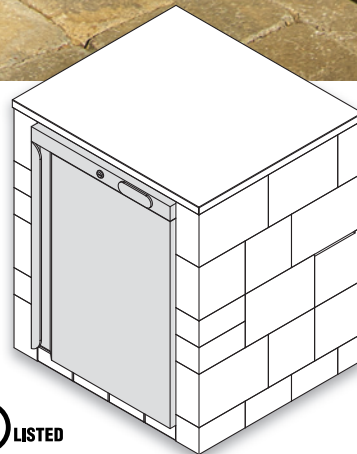

the **smoker, trash, corner** and **two drawer** cabinets

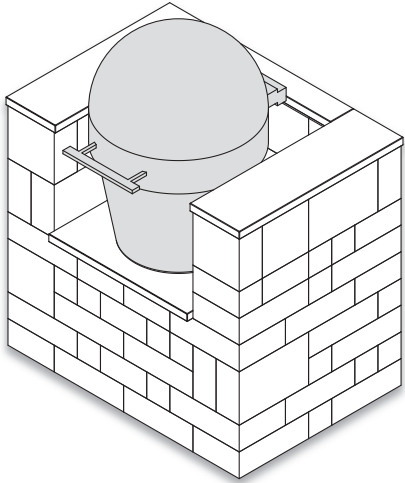

Smoker cabinet

- 24" W x 24" D opening
- Ideal for your smoker
- Choice of granite/cabinet colors

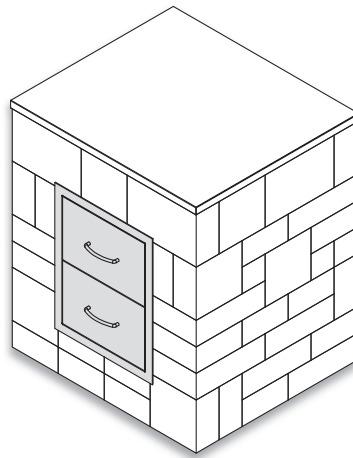

Two drawer cabinet

- Easy-glide, enclosed stainless steel drawers
- Choice of granite/cabinet colors

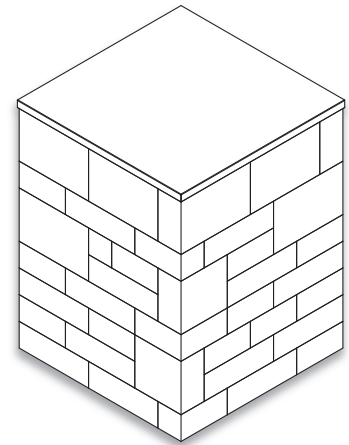

Corner cabinet

- Creates L-shaped kitchen designs
- Choice of granite/cabinet colors

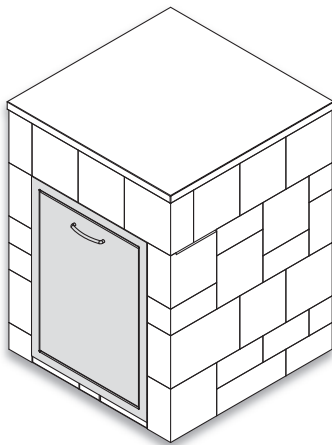

Trash cabinet

- #304 stainless steel construction
- Easy-glide drawer accommodates 12 gal. trash can
- Choice of granite/cabinet colors



Summerset's trash drawer is completely enclosed to protect against animals and insects.

Smoker not included or available.



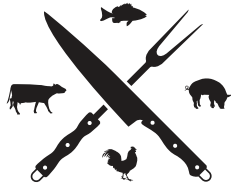

the kitchen™
by necessities

All dimensions shown in inches.

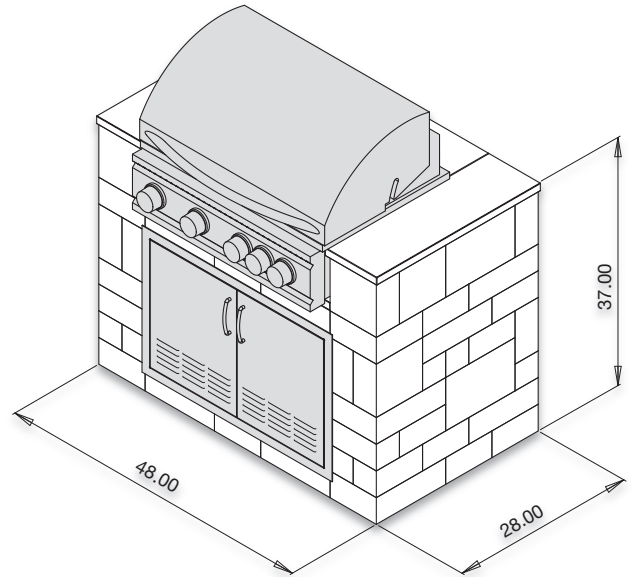

32" Sizzler Grill Cabinet

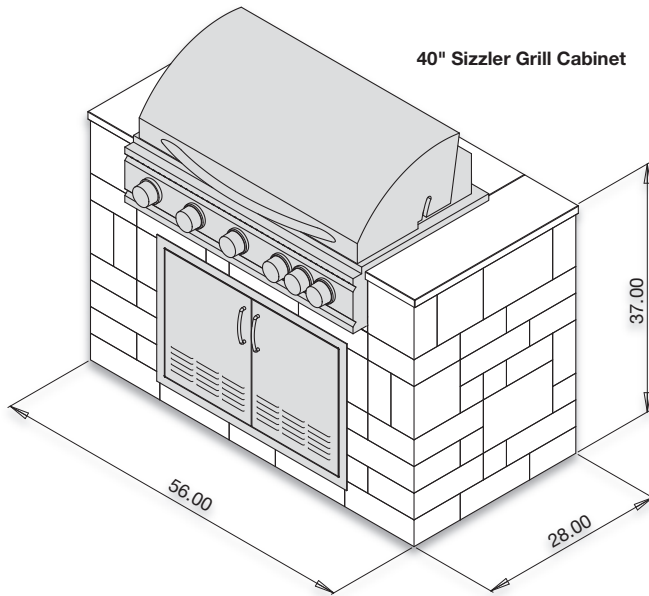

40" Sizzler Grill Cabinet

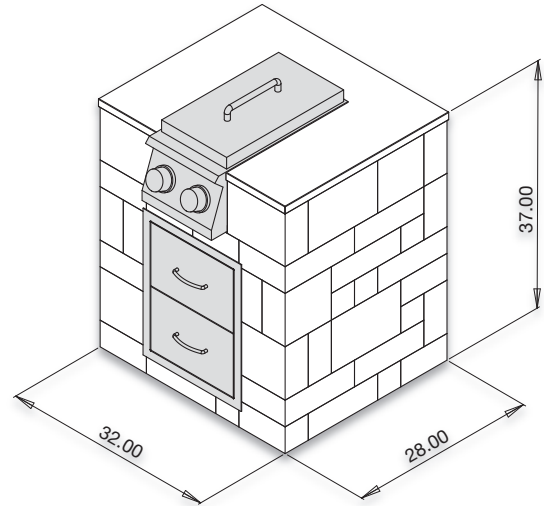

Side Burner Cabinet

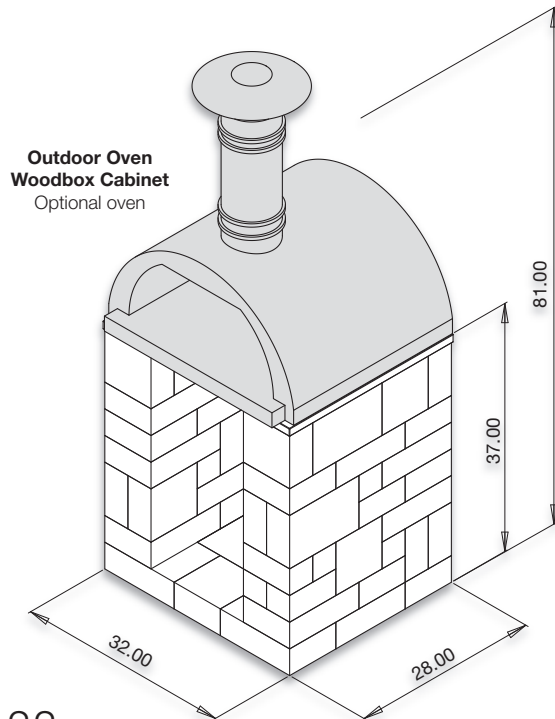

**Outdoor Oven
Woodbox Cabinet**
Optional oven

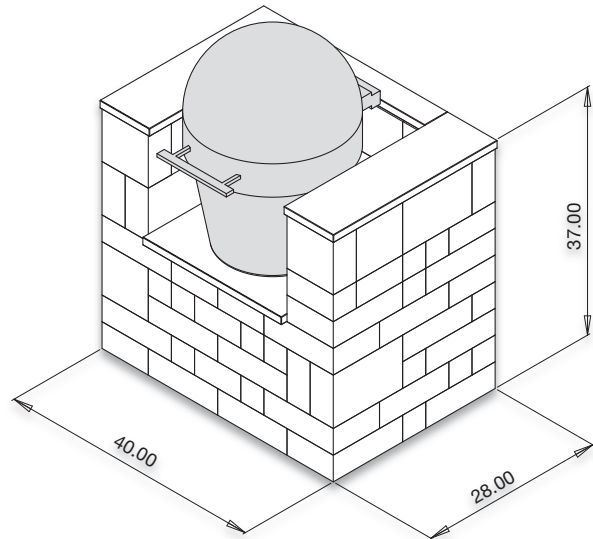

Smoker Cabinet
Smoker not included

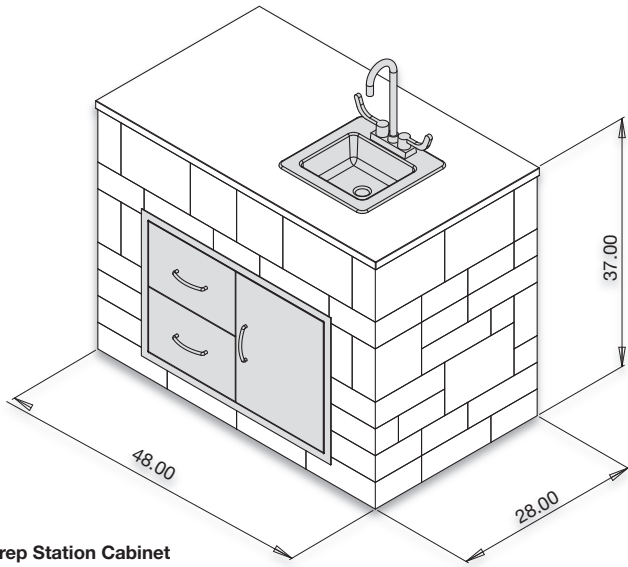

Prep Station Cabinet
Optional sink

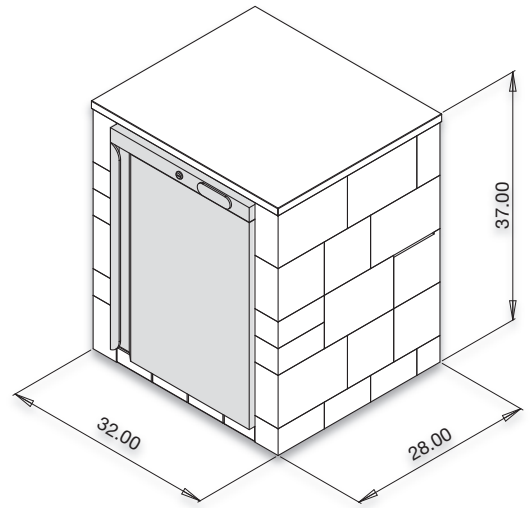

Refrigerator Cabinet
Optional refrigerator

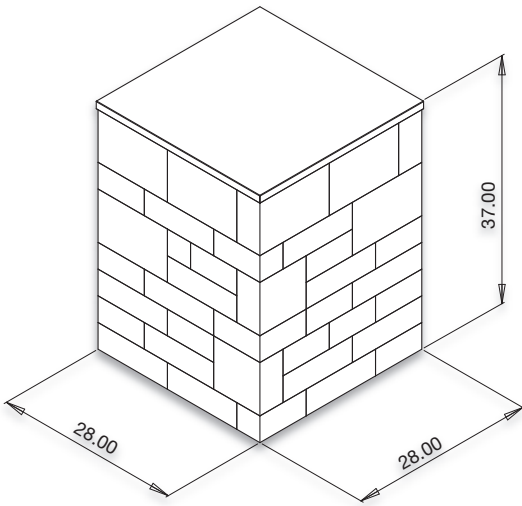

Corner Cabinet

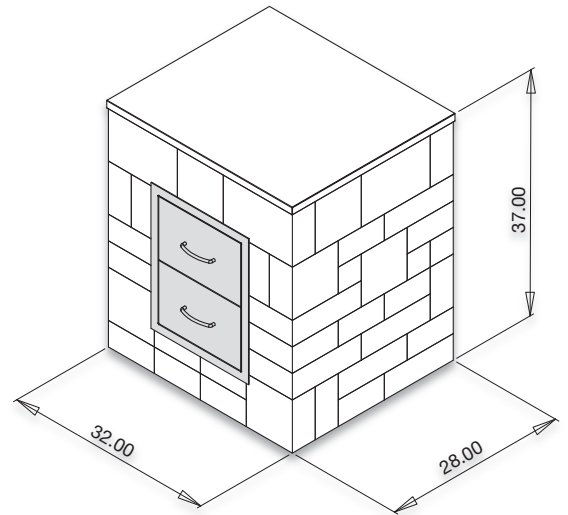

Two Drawer Cabinet

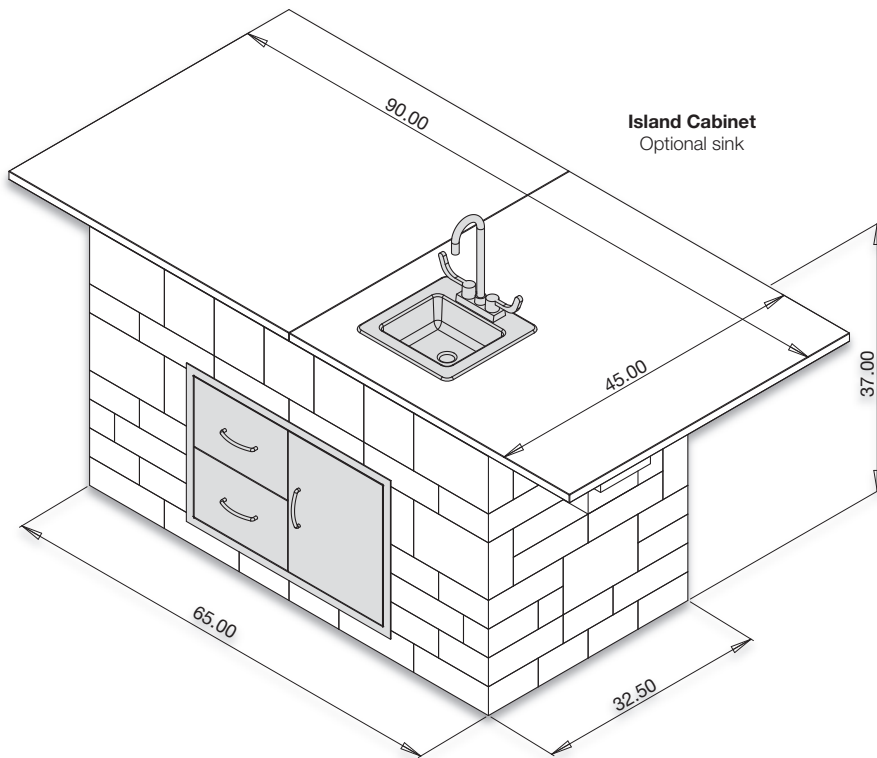

Island Cabinet
Optional sink

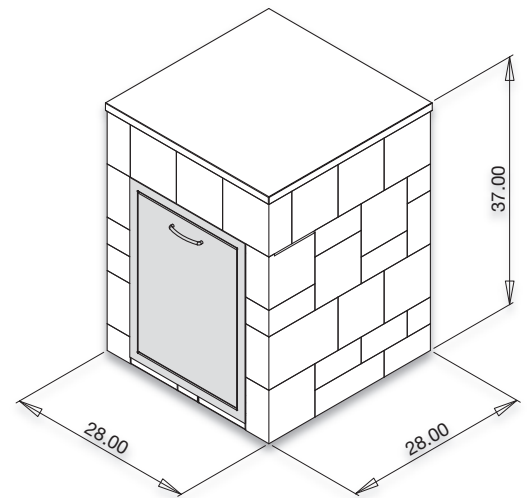

Trash Cabinet



See Necessary's complete line of affordable, ready-to-assemble outdoor fireplaces, waterfalls, kitchen/bars, tables, fire rings, pillars and seat wall kits.

www.outdoorlivingkits.com



Shown: Necessary's Victorian Fireplace, Seat Wall and Pillar Kits.

ROCKWOOD[®]
RETAINING WALLS
A better way.[™]

Rockwood Retaining Walls, Inc.
325 Alliance Place NE, Rochester, MN 55906
Phone: 507-529-2871

©2018 Rockwood Retaining Walls, Inc. All rights reserved. All trademarks, service marks and trade names referenced in this material are the property of their respective owners. Made worldwide under license from Rockwood Retaining Walls, Inc. U.S. and international patents issued and pending. This information has been prepared for the benefit of customers interested in Necessary's Outdoor Living Kits. It was reviewed carefully prior to publication. Rockwood assumes no liability for its accuracy or completeness. Final determination of the suitability of any information or material for the use contemplated, or for its manner of use, is the sole responsibility of the user. Rockwood Retaining Walls reserves the right to change product specifications at any time without incurring obligations. 418