

10TH EDITION



Mid-Atlantic™

CONCRETE PRODUCTS

**WELCOME  
TO THE BACKYARD...**



# YOU'RE GOING TO LOVE IT OUT HERE!



## TILES, PAVERS & PORCELAIN

ANTIQUE TRAVERTINE LANDSCAPE TILES .....	12
BARN PLANK LANDSCAPE TILES .....	14
BELGARD PAVERS AND WALLS .....	16-21
PATIO & ROOFTOP DECKING .....	10
PORCELAIN PAVERS .....	28-31
SLATE LANDSCAPE TILES .....	6-9

## NATURAL STONE

FLAGSTONE PAVERS .....	22
TRAVERTINE PAVERS .....	24
FLAGSTONE, FIELDSTONE AND BOULDERS .....	26

## RETAINING WALLS

BARN PLANK GARDEN WALL .....	40
CLASSIC® 8 .....	44
HERITAGE BLOCK .....	38
KEYSTONE COMPAC III AND STANDARD III .....	46
PREMIER 9D COLONIAL .....	34
PREMIER 8 .....	37
PREMIER 9D .....	36
ROSETTA KODAH AND OUTCROPPING .....	42
STONELEDGE .....	32



Note: Our products are made from solid color concrete for lasting appearance and durability. Photographs contained herein are for representation only. Refer to actual product samples when making color selection. Product dimensions given are nominal.

The information presented here has been prepared for the benefit of customers interested in Mid-Atlantic Concrete Products and was reviewed carefully prior to publication. Mid-Atlantic Concrete Products assumes no liability for its accuracy or completeness. Final determination of the suitability of any information or material for the use contemplated, or for its manner of use, is the sole responsibility of the user. Product specifications, colors and availability subject to change at any time.



www.midatlanticcp.com



**Mid-Atlantic**<sup>™</sup>  
CONCRETE PRODUCTS



**OUTDOOR LIVING KITS** ..... 52

COMPACT BAR ..... 58

DINING AND PUB TABLES ..... 58

FIREPLACES ..... 54

FIRE RINGS ..... 56

GRAND ISLAND BAR SERIES ..... 57

PILLARS ..... 59

SEATWALLS ..... 59

WATERFALLS ..... 59

KIT DIMENSIONS ..... 60 and 66

**KITCHEN CABINET KITS** ..... 62

ISLAND CABINET ..... 64

REFRIGERATOR AND PREP CENTER CABINETS ..... 64

SIZZLER GRILL CABINETS ..... 63

SMOKER, SIDE BURNER, STORAGE AND CORNER CABINETS ..... 65

WOODBBOX/STAND ..... 63

**ACCESSORIES**

CHISELED CAPS & TOPS ..... 48

CHISELED STEPS ..... 53

SANDS, SEALERS AND CLEANERS (PROTECT YOUR INVESTMENT) ..... 67

WET CAST STEPS ..... 50



# WELCOME

# TO MID-ATLANTIC







WELCOME TO MID-ATLANTIC CONCRETE PRODUCTS. WE ARE THE SOUTHEAST'S LEADING MANUFACTURER AND DISTRIBUTOR OF THE HIGHEST QUALITY OUTDOOR LIVING, RETAINING WALL, LANDSCAPE TILE, NATURAL STONE AND PAVER BRANDS.

Mid-Atlantic Concrete is the preferred source of both homeowners and residential and commercial landscape contractors for our high-quality product offering, exceptional customer service and attention to detail.

Our brands include: Silver Creek Stoneworks® landscape tiles, steps, pavers, caps & tops; Belgard® pavers; Rockwood® Retaining Walls, Heritage Block™, Keystone, Rosetta and CornerStone retaining walls; Landmark porcelain pavers; natural stone; Necessaries™ Outdoor Living and Kitchen Kits and professional landscaping accessories and components.

Whether you are looking to create an outdoor living room, backyard kitchen, or a retaining wall to expand and support your landscape, this comprehensive catalog is designed to serve as your design gallery. There aren't enough pages to tell the entire story, so we invite you to see more inspirational and award-winning landscapes online at [www.midatlanticcp.com](http://www.midatlanticcp.com)



**Mid-Atlantic™**  
CONCRETE PRODUCTS

2460 Armstrong Dr., Winston-Salem, NC 27103 • Phone: 336-774-6544



# SLATE



*Silver Creek*  
STONWORKS

# LANDSCAPE TILES

SLATE'S RICH TEXTURE COMES FROM ACTUAL STONE QUARRIED IN THE NORTHEASTERN U.S., WHERE STONE CRAFTSMANSHIP DATES BACK TO COLONIAL AMERICA.



# SLATE LANDSCAPE TILES

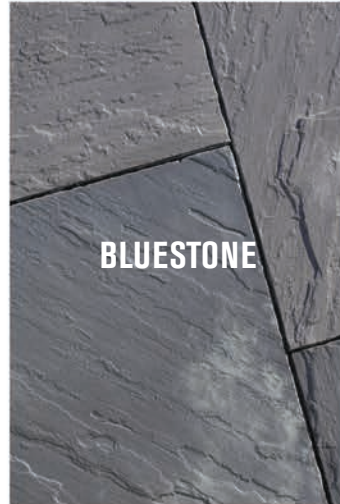

Refer to actual product samples when making color selection.

**Slate Landscape Tiles** have the look of hand-split quarried stone, their chiseled edges are ideal for treads, tops and caps. For use on paths, patios and pool decks.

- Lays quickly, patterned or random
- Unique 24" x 36" XL slab
- Gap tiles 1/4" or more

**Separate Pallets:**

- 12" W x 12" D x 1.5" H
- 12" W x 24" D x 1.5" H
- 24" W x 24" D x 1.5" H
- 24" W x 36" D x 1.5" H (XL)
- 14" W x 14" D x 1.5" H (bullnose unit)





SILVER CREEKS STONEWORKS' LANDSCAPE PRODUCTS ARE STRONG (10,000 PSI) WET CAST REPRODUCTIONS OF HANDCRAFTED ORIGINALS. THESE MANUFACTURED LANDSCAPE PRODUCTS LOOK AND FEEL LIKE THE REAL THING AND ALL ARE BACKED BY A LIMITED LIFETIME WARRANTY.



SEE COMPLETE WARRANTY AT:  
[WWW.SILVERCREEKSW.COM](http://WWW.SILVERCREEKSW.COM)





Mid-Atlantic  
CONCRETE PRODUCTS

Slate's chiseled edge detail and bullnose tiles are perfect for step treads, pool coping and tops.





# PATIO DECKING

## WITH CONCRETE

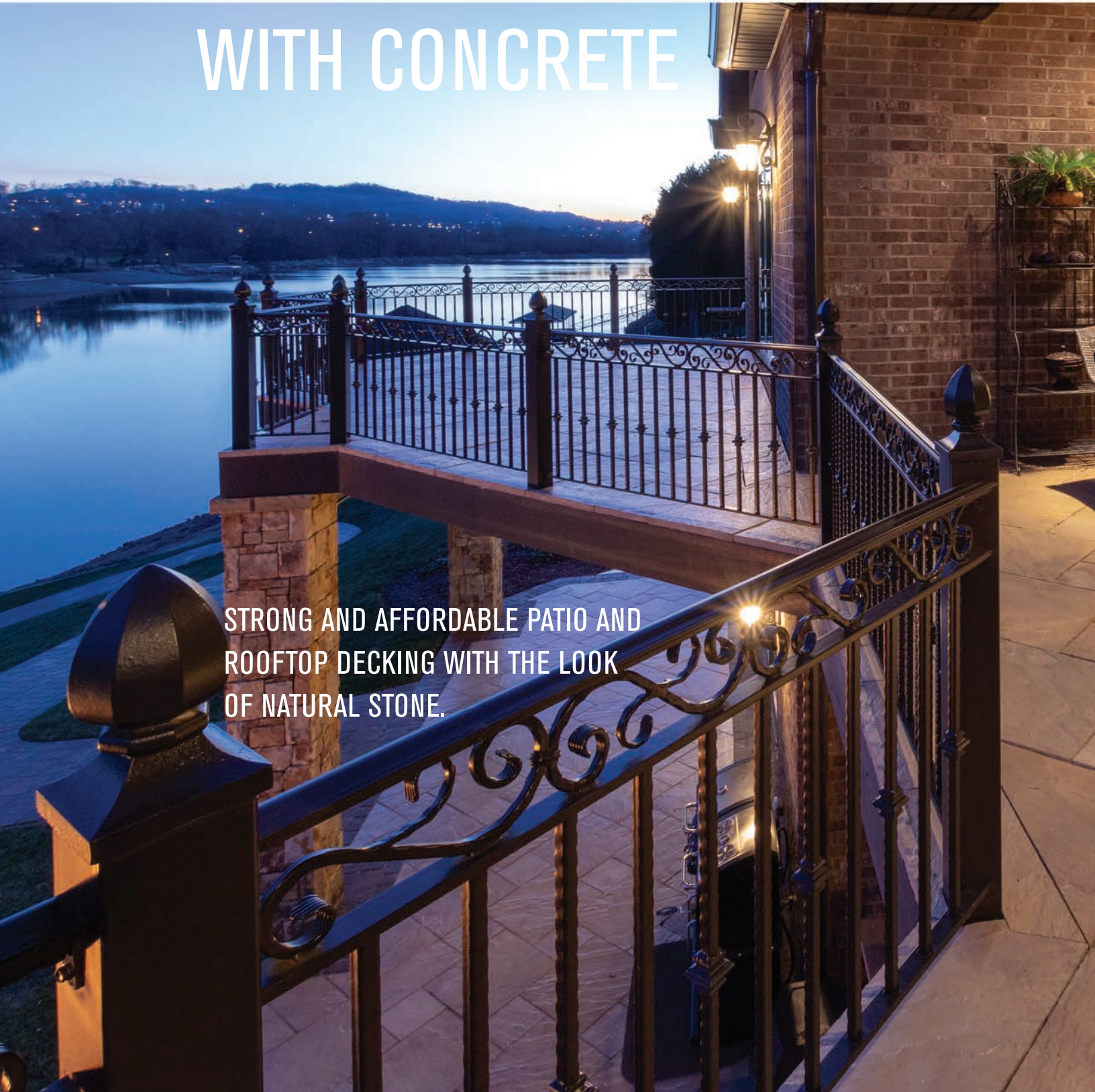

STRONG AND AFFORDABLE PATIO AND  
ROOFTOP DECKING WITH THE LOOK  
OF NATURAL STONE.





Silver Creek®  
STONEWORKS



Silver Creek landscape tiles are the newest material choice for patio decking. Property owners will not only enjoy the look and feel of natural stone on their raised patio, they'll never have to scrape, paint, or stain a conventional wood deck again.

Aside from creating valuable and attractive outdoor spaces, rooftop pedestal decks have many benefits. These unique systems can promote energy efficiency, protect membrane roofing, help reduce noise, hide drainage and utilities, and allow easy access to what's below.



Always consult a structural engineer for proper deck design.

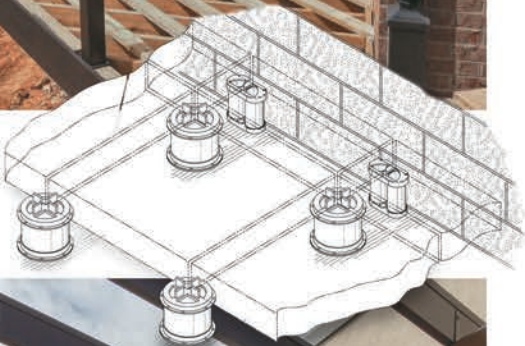



# TRAVERTINE

## LANDSCAPE TILES



CAST FROM MASTERS QUARRIED IN TIVOLI, ITALY – THE RENOWNED ORIGINAL IS FOUND ON FAMOUS LANDMARKS SUCH AS THE ROMAN COLOSSEUM, ST. PETER'S BASILICA, THE GETTY CENTER AND LINCOLN CENTER.



# ANTIQUe TRAVERTINE LANDSCAPE TILES



*Silver Creek*  
STONEWORKS

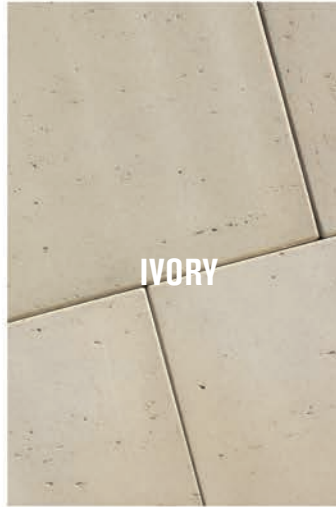

IVORY

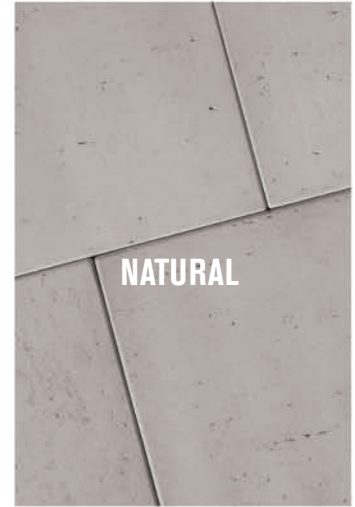

NATURAL

Refer to actual product samples when making color selection.



**Antique Travertine Landscape Tiles'** smooth, honed surface is so authentic, only you'd know they are man-made. A truly timeless look for paths, patios and pool decks. Gap tiles 1/4" or more.

**Sizes Palletized Separately:**

- 12" W x 24" D x 2" H
- 18" W x 24" D x 2" H
- 24" W x 24" D x 2" H
- 12" W x 24" D x 2" H (coping unit)



# BARN PLANK

## LANDSCAPE TILES

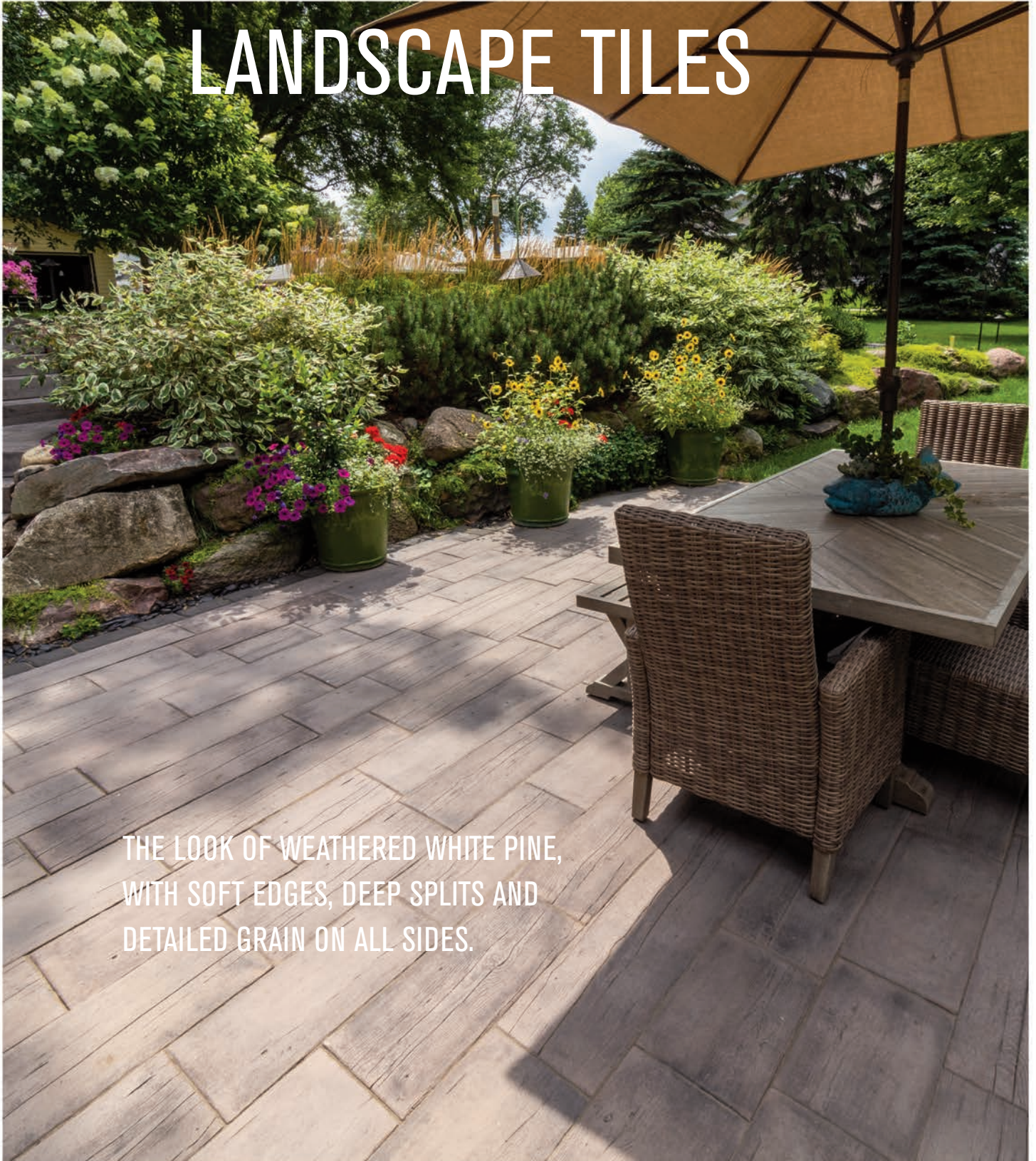

THE LOOK OF WEATHERED WHITE PINE,  
WITH SOFT EDGES, DEEP SPLITS AND  
DETAILED GRAIN ON ALL SIDES.



# BARN PLANK LANDSCAPE TILES



*Silver Creek*  
STONEWORKS



**WEATHERED GRAY**

GRAY/BLACK

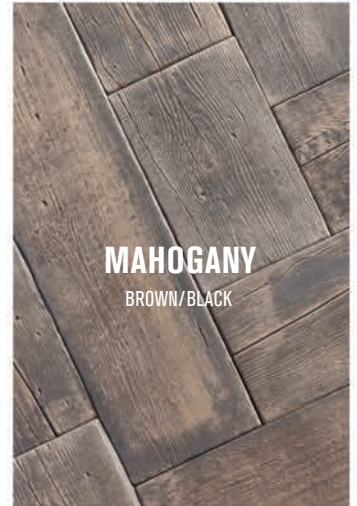

**MAHOGANY**

BROWN/BLACK

Refer to actual product samples when making color selection.



**Barn Plank Landscape Tiles** are manufactured with a surface-applied protectant to help resist the harmful effects of time, Mother Nature, acid rain and stains. Unlike cut lumber, these will never warp, splinter or rot.

- Deep splits, detailed grain top & sides
- For paths, patios, pools and overlays
- Matching Step and Garden Wall block
- Gap tiles 1/4" or more

**Separate Pallets:**

- 15.5" W x 9.75" D x 2" H
- 23.37" W x 9.75" D x 2" H
- 35" W x 9.75" D x 2" H





SEE ALL OUR BELGARD PAVER  
AND WALL PRODUCTS

at: [www.midatlanticcp.com](http://www.midatlanticcp.com)

# BELGARD

## PAVERS



SINCE 1995, BELGARD HAS SET THE STANDARD  
FOR INNOVATIVE AND QUALITY OUTDOOR  
HARDSCAPES WITH ITS INTERLOCKING  
CONCRETE PAVERS.



# BELGARD PAVERS





PAVERS AND SLABS

YOUR LOCAL PROFESSIONAL WILL  
HELP FIND THE RIGHT PRODUCTS  
FOR YOUR BACKYARD.

# BELGARD

## PAVERS







Mid-Atlantic  
CONCRETE PRODUCTS



# BELGARD



## WALLS & PAVERS





BELGARD PAVERS & WALLS





# FLAGSTONE

## PAVERS



EACH FLAGSTONE IS DISTINCT, WITH UNIQUE AND VARYING COLOR PALETTES, DIFFERING RIVEN SURFACES, NATURAL VEINING AND OCCASIONAL FOSSIL PRINTS.



# NATURAL STONE



Quarried and calibrated natural flagstone (nominal dimensions).

- 12" W x 12" D x 1.2" H
- 24" W x 12" D x 1.2" H
- 24" W x 24" D x 1.2" H
- 24" W x 36" D x 1.2" H

Refer to actual product samples when making color selection.





THESE QUARRIED PAVERS  
ARE AS AFFORDABLE AS  
THEY ARE BEAUTIFUL.

# TRAVERTINE

## PAVERS





# NATURAL STONE

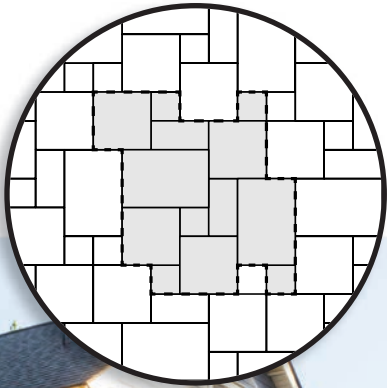

These extremely popular and affordable quarried, natural travertine tiles are calibrated and surface polished. Each pallet has 176 sq. ft. and is designed to be installed in a French pattern. Matching 24" W x 12" D full bullnose for coping and treads.

- 8" W x 8" D x 1.25" H
- 8" W x 16" D x 1.25" H
- 16" W x 16" D x 1.25" H
- 16" W x 24" D x 1.25" H

Refer to actual product samples when making color selection.



Mid-Atlantic™  
CONCRETE PRODUCTS



# NATURAL FIELD AND FLAGSTONE



## Pier Caps

- 24 X 24 x 2" H
- Natural Stone, finished all sides



## Wall Caps

- 24 X 24 x 2" H
- Natural Stone, finished three sides
- Buff or Gray Castle colors



## Step Blocks

- 48 X 16 x 6"
- Natural Stone, finished all sides
- Buff or Gray Castle colors





# NATURAL STONE

We inventory an extensive selection of quarried Tennessee flagstone and fieldstone for construction and landscape contractors.



**STEPPERS**



**FIRE BOULDERS**



**LANDSCAPE BOULDERS**



**GRAY FLAGSTONE**



**THIN STACKED FLAGSTONE**

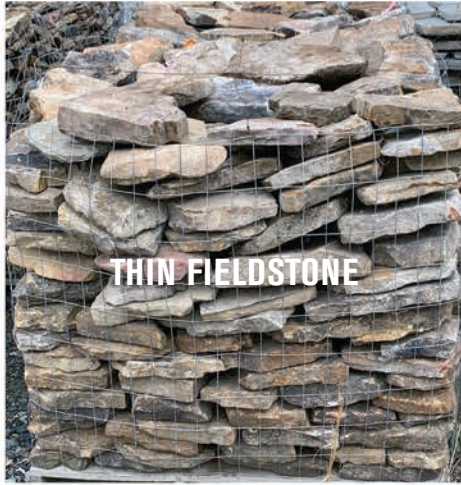

**THIN FIELDSTONE**



**TAN FLAGSTONE**



**MEDIUM STACKED FLAGSTONE**



**MEDIUM FIELDSTONE**



# PORCELAIN PAVERS

## PORCELAIN PAVERS VS. OTHER OUTDOOR PAVING MATERIALS

Features	Frontier20 Porcelain Pavers	Wood Pavers	Clay Brick	Concrete (CIP) Cast In Place	Concrete Pavers	Natural Stone
Stainable	No	Yes	Yes (Highly)	Yes	Yes	Yes (Highly)
Freeze/Thaw Proof	Yes	No	No	No	No	No
Salt Resistant	Yes	No	Salt will Degrade	No	No	No
Acid Resistant	Yes	No	Acid will Burn	No	No	No
Scratch Resistant	Highly	No	Somewhat	No	No	No
Moisture Absorption	< 0.5%	Highly Varied	5%	5%	5-10%	> = 5%
Easy-to-Repair	Yes	Yes	No	Can Not	No	No
UV Resistant	Unaffected	No	Yes if Sealed	Yes	No	Unaffected
Needs Sealing	Never	Yes	Recommended	Recommended	Recommended	Recommended
Pressure Washer Safe	> 1500 PSI	No	Not Recommended	> 1500 PSI	No	No
Environmentally Friendly	Facility 98% Green	Many Exotic Rainforest Species	No	Large Carbon Foot Print	Possible Fly Ash Content	Mined or Imported
Recycled Content	20% In Each Paver	No	Not Possible	Not Possible	If Possible Less than 5%	Not Possible

### GRIP FINISH (9MM)

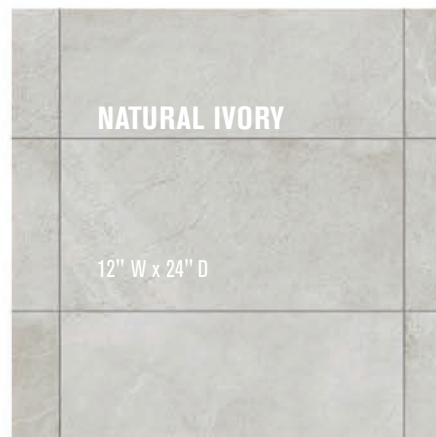



# FRONTIER20 PORCELAIN PAVERS



Frontier20 are porcelain pavers designed and manufactured to withstand decades of exposure to destructive conditions from wear, Mother Nature, chemicals and freeze/thaw cycles that can destroy some composite, wooden and concrete products. These stain-proof, slip-resistant, chemical-resistant, no-maintenance porcelain tiles can be installed using a traditional mortared bed, a sand/limestone set or as an elevated deck or pedestal application and can be utilized in a eco-friendly permeable application.

- Slip-resistant, waterproof, stain-proof, scratch/dent-resistant, fire-resistant
- Outdoor/indoor friendly
- Easy to clean
- Tiles are 20mm or .787" tall
- Grip-finish floor, wall and countertop tiles are 9mm tall
- Matching trim, tread, coping, drain, riser and corner units

Refer to actual product samples when making color selection.

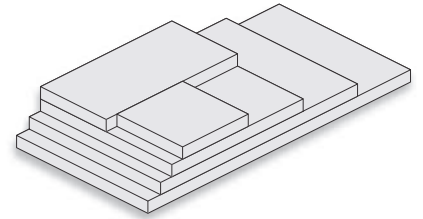

## CONCRETE LOOK (20MM)

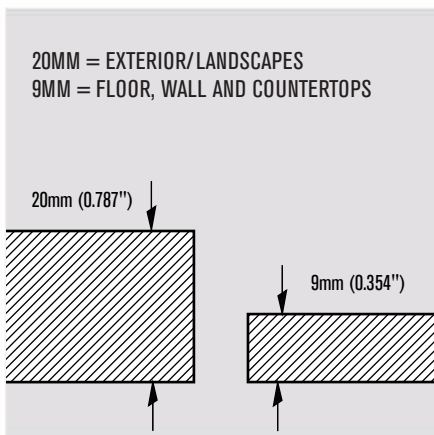
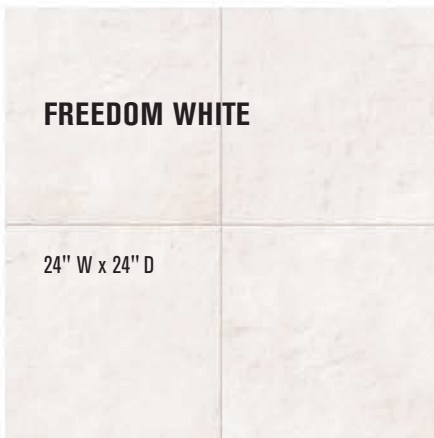





**TRAVERTINE LOOK (20MM)**

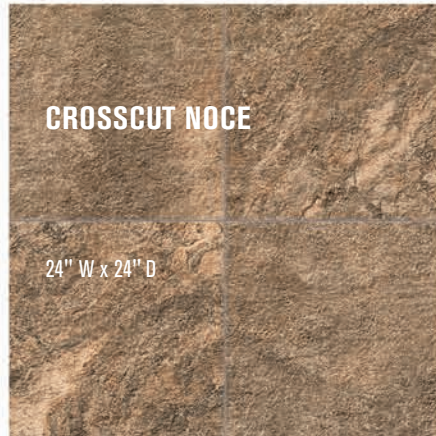

**BLUESTONE LOOK (20MM)**





# FRONTIER20 PORCELAIN PAVERS



CREATED FOR OUTDOOR USE, THESE TILES ARE INHERENTLY SLIP RESISTANT AND IMPERVIOUS TO CHEMICALS, SALT, FADING, OR SCRATCHING.

## WOOD LOOK (20MM)

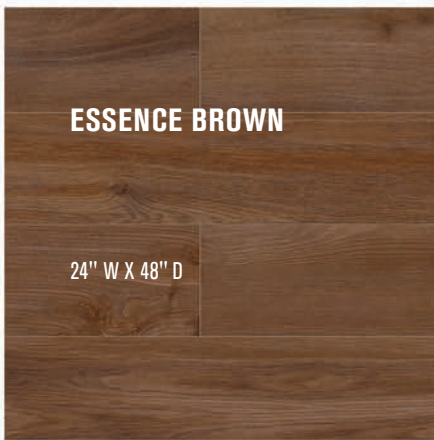

## STONE LOOK (20MM)

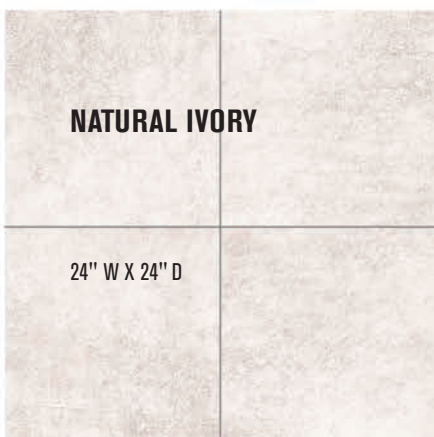



# STONELEDGE

## RETAINING WALL



STONELEDGE BLOCKS ARE DOUBLE-SIDED AND CAN EASILY BUILD FREE-STANDING SEATWALLS, PILLARS AND RETAINING WALLS.



# STONELEDGE RETAINING WALL

Created as a multi-sized, double-sided, tapered unit, **StoneLedge** creates the hand-finished look of quarried stone, perfect for creative residential or commercial projects. Flag connectors on each block create strong, vertical or 4.5' setback retaining walls.

### StoneLedge Wall Blocks:

- 18/15" W x 10" D x 6" H
- 12/9" W x 10" D x 6" H
- 6/3" W x 10" D x 6" H
- 14/12" W x 12.5" D x 3" H (cap)
- 18" W x 9" D x 6" H (corner)

TUMBLED





# PREMIER 9D

## COLONIAL WALL

PREMIER 9D COLONIAL HAS A DISTINCTIVE LOOK  
THAT APPEALS TO BOTH RESIDENTIAL AND  
COMMERCIAL PROPERTY OWNERS.



# PREMIER 9D COLONIAL RETAINING WALL

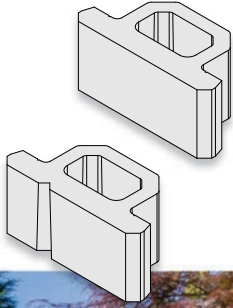

- Premier 9D Colonial Blocks:**
- 18" W x 9" D x 8" H
  - 7° setback
  - Matching cap block





# PREMIER RETAINING WALLS

PREMIER 9D IS THE CHOICE FOR LARGE PROJECTS WHERE PERFORMANCE, COST AND EFFICIENCY ARE CRITICAL CONSIDERATIONS.

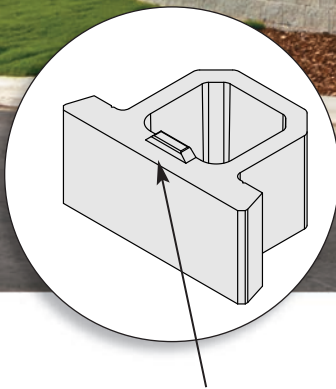

The anchor bar under each block creates an automatic 1" setback. When built, its gravel-filled cores create vertical "stone columns" that produce a multi-point interlock for a more uniform block-to-block connection.

Premier's patented, lightweight design beats all other block systems for strength, performance, freight efficiencies and ease of construction.

**Premier 9D** is the lightest weight retaining wall unit per square foot. in the industry and is one of the most cost-effective systems available.

- 18" W x 9" D x 8" H
- 49 lbs.
- 7" setback
- Matching cap block

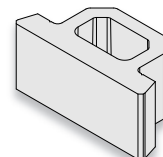



# PREMIER RETAINING WALLS

Just like Rockwood's Premier 9D, **Premier 8** retaining wall blocks are straight split-face units designed for serious performance, lightweight economics and versatility.

- 18" W x 12" D x 8" H
- 54 lbs.
- 7" setback
- Matching cap block

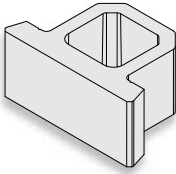

**BROWN**

West only



**DESERT TAN**

East only



**GRAY**

East and West





# HERITAGE BLOCK

## WALLS



HERITAGE BLOCK COMBINES THE DESIRABLE LOOK OF NATURAL STONE WITH THE ADVANTAGES OF SOLID PERFORMANCE.



Garden Wall Fire Pit Kit (gas version not available)

**Garden Wall Blocks:**

Five-block system builds vertical walls without pins, clips or rear lip.

- 12/8" W x 7.5" D x 4" H
- 16" W x 10" D x 1" H (cap)





# HERITAGE BLOCK RETAINING WALLS



Demanding retaining walls don't have to sacrifice great looks for high performance. Heritage Block walls combine the desirable look of natural stone with the advantages of segmental concrete.

**Heritage Wall Blocks:**

- 16/12" W x 17" D x 6" H
- 24/17" W x 17" D x 6" H
- 24" W x 16" D x 6" H (2 sided)
- 24" W x 16" D x 6" H (3 sided)
- 25" W x 21" D x 1.5" H (cap)

Refer to actual product samples when making color selection.





# BARN PLANK



Silver Creek®  
STONEWORKS

## GARDEN WALL



THE LOOK OF RECLAIMED WOODEN BEAMS  
IN STRONG, WET CAST CONCRETE.



- Barn Plank Wall:**
- Detailed grain and color on five sides
  - 162 lbs.
  - 40" W x 8" D x 6" H



# BARN PLANK GARDEN WALL



- Barn Plank Step:**
- 48" W x 18" D x 5.75" H
  - 450 lbs.
  - Mahogany or Weathered Gray

- Barn Plank Fire Pit Kit:**
- Four-piece heavy gauge steel insert protects block
  - Optional, removable swivel cooking grate





# ROSETTA

## WALLS



### KODAH WALL

**Kodah Wall** blocks are strong and versatile, two-sided wet cast blocks. For use as garden walls, freestanding vertical retaining walls, seatwalls and planters.

- Four sizes on one pallet
- 12", 21", 30" and 42" lengths x 10.5" D x 6" H
- 21" W x 10.5" D x 6" H (corner)



SENECA



APPALACHIAN BROWN



# ROSETTA RETAINING WALLS



**Outcropping Walls** are strong, wet cast retaining wall blocks designed for serious performance and maximum curb appeal.

- 14 unique shapes on multiple pallets
- 6, 12", 18" and 24" heights x 24" to 72" widths
- 30 x 48" x 12" H (corner)
- 15 setback
- Lifting device required





# CLASSIC 8

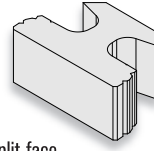

Straight-split face

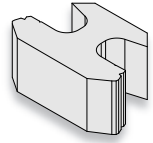

Beveled split face

## RETAINING WALL

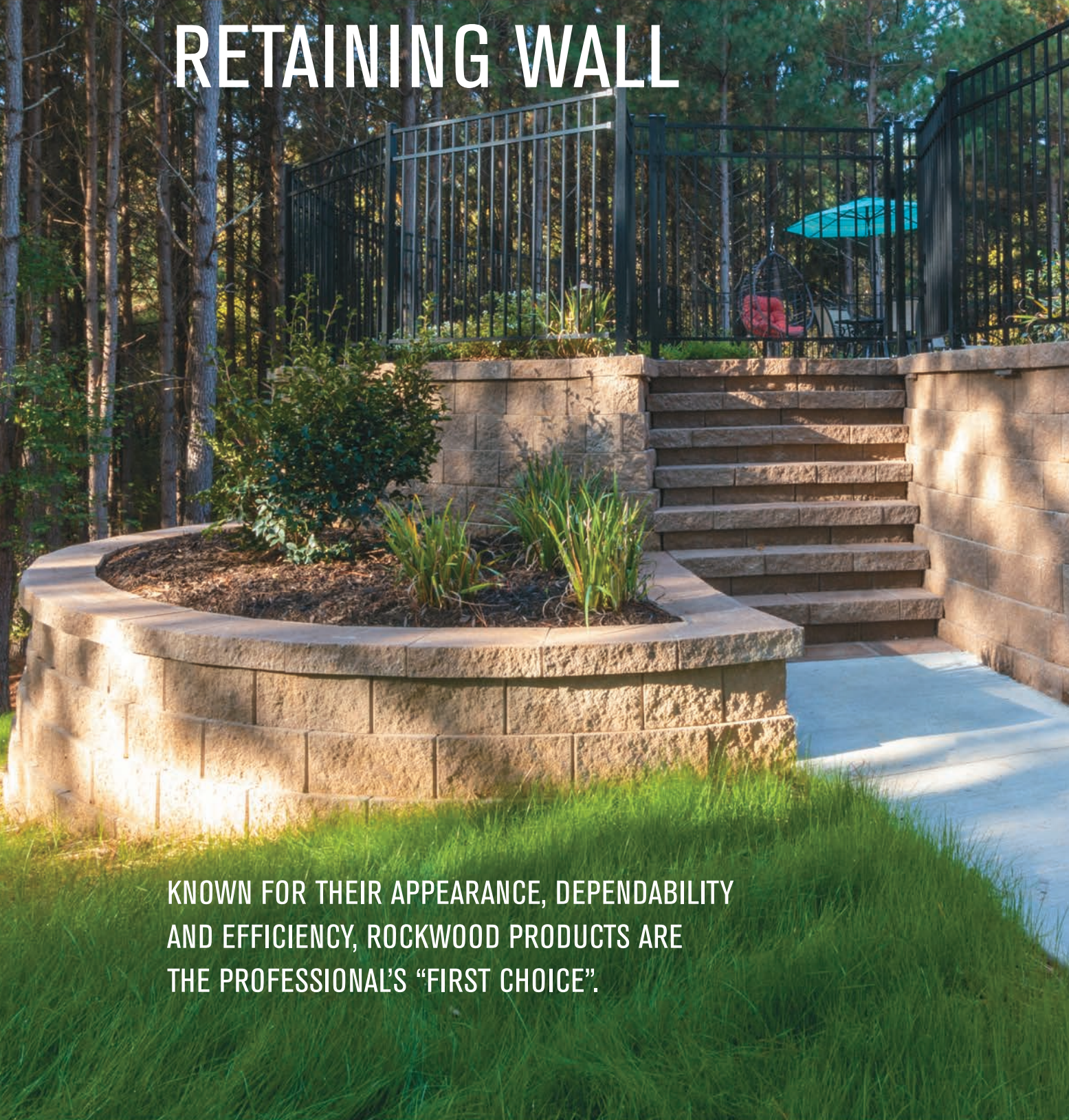

KNOWN FOR THEIR APPEARANCE, DEPENDABILITY AND EFFICIENCY, ROCKWOOD PRODUCTS ARE THE PROFESSIONAL'S "FIRST CHOICE".



**ROCKWOOD®**  
 RETAINING WALLS  
*A better way.™*

**CLASSIC 8 RETAINING WALL**



**SADDLE BROWN**

Special order



**BROWN**

West only



**DESERT TAN**

East only



**GRAY**

East and West

Appealing to homeowners, contractors and designers alike, **Classic 8** is as attractive as it is versatile. Capable of sharp radius turns, variable setbacks and endless design possibilities. **Classic 8** is perfect for any retaining wall project, no matter how large or how small.

- 18" W x 12" D x 8" H
- 7" setback
- Beveled or straight face
- Matching cap block

Refer to actual product samples when making color selection.





Standard and Compac wall blocks  
require two non-shoulder pins per unit.



# KEYSTONE

# RETAINING WALLS







# KEYSTONE RETAINING WALLS

Known for its cost savings, versatility and proven wall performance, **Compac III** features a lighter weight and shorter tail design that makes it easy to handle.

- 18" W x 12" D x 8" H (1" or 8" setback)
- 18" W x 9" D x 8" H (corner block)

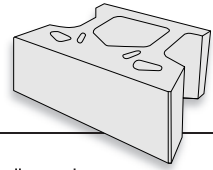

The **Keystone Standard III** unit's height-to-depth ratio delivers a structurally sound, engineered wall system with superior construction stability, durability, and strength.

- 18" W x 21" D x 8" H (1" or 8" setback)
- Tri-plane split (special order)







*Silver Creek*  
STONEWORKS

# CHISELED

# CAPS AND TOPS

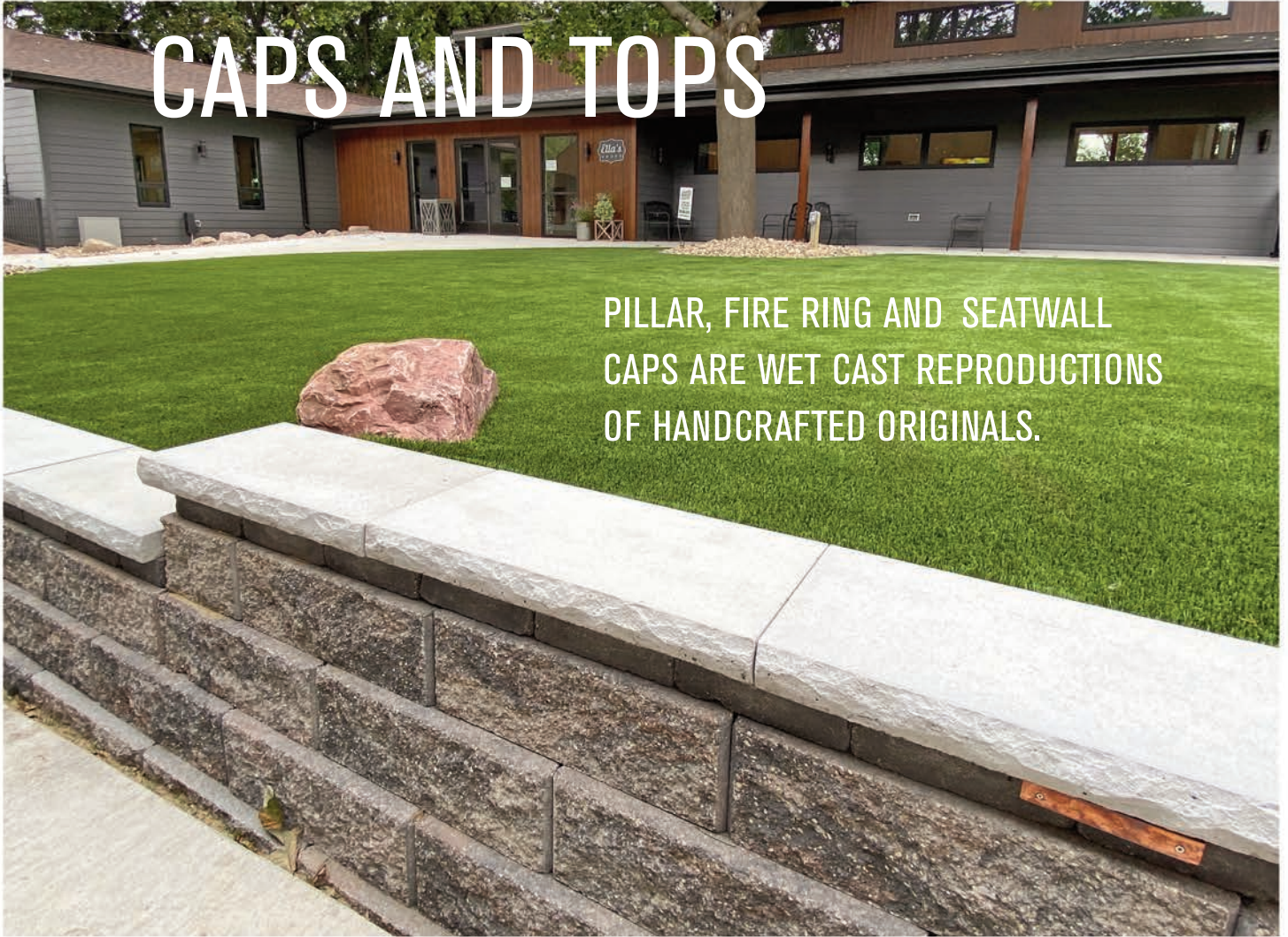

PILLAR, FIRE RING AND SEATWALL  
CAPS ARE WET CAST REPRODUCTIONS  
OF HANDCRAFTED ORIGINALS.





# CHISELED CAPS

## INDIANA LIMESTONE



## BUFF



## BLUESTONE

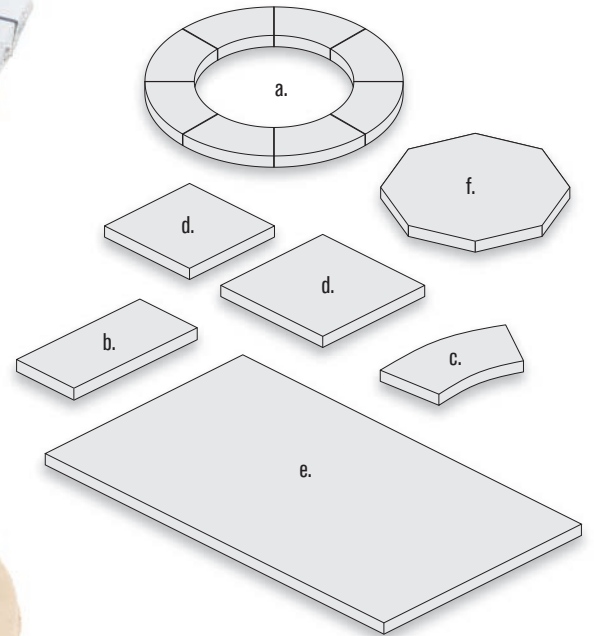

**Caps and Tops** have the look of handcrafted limestone with hewn tops and chiseled sides. Use for pillars, seat/retaining walls, fire rings and custom outdoor features.

- a) Fire Ring Caps:**  
 - Chiseled outside edge  
 - 8 pieces/set  
 - 10" D x 2.25" H

- b) Straight Wall Caps:**  
 - Chiseled two sides  
 - 24" W x 12" D x 2.25" H

- c) Radius Wall Caps:**  
 - Chiseled two sides  
 - 18.75" W x 12" D x 2.25" H

- d) Pillar Caps:**  
 - Chiseled four sides  
 - 25" W x 25" D x 2.25" H  
 - 30" W x 30" D x 2.25" H

- e) Bar Tops:**  
 - Choose from chiseled front and back, or chiseled three sides  
 - 36" W x 48" D x 2.25" H  
 - Indiana Limestone only

- f) Octagon Top:**  
 - Chiseled edge  
 - 36" W x 36" D x 2.25" H  
 - Indiana Limestone only

Refer to actual product samples when making color selection.



# WET CAST

# STEPS

SILVER CREEK STEPS ARE STRONG,  
WET CAST REPRODUCTIONS OF  
HANDCRAFTED ORIGINALS.



**Barn Plank Steps** look just like reclaimed pine beams with detailed splits and grain on tops and sides.

- 48" W x 18" D x 5.75" H (450 lbs.)
- Matching landscape tiles and garden wall blocks



MAHOGANY

WEATHERED GRAY



# WET CAST STEPS



BLUESTONE



BUFF

**Chiseled Steps** are heavy, wet cast units with the look of handcrafted limestone in two styles.

- 48" W x 18" D x 5.75" H (450 lbs.)
- Chiseled riser with smooth top and sides
- Chiseled three sides with rough top



INDIANA Limestone

Chiseled three sides, rough top.

Chiseled face, smooth top and sides.





# NECESSARIES™

## OUTDOOR LIVING KITS



No cutting, no guessing, no hassles – no problem®  
*necessaries™*  
kits for outdoor living

**ROCKWOOD**  
RETAINING WALLS  
A better way™

[www.outdoorlivingkits.com](http://www.outdoorlivingkits.com)



# NECESSARIES IS A COLLECTION OF AFFORDABLE, READY-TO-ASSEMBLE KITS FOR OUTDOOR FIREPLACES, ISLAND BARS AND GRILLS, TABLES, WATERFALLS, FIRE RINGS, SEATWALLS AND PILLARS.



### Necessaries Standard Features:

- Easy-to-read, step-by-step instructions
- Rockwood's multi-piece Lakeland & Riverland blocks
- Reinforcements and concrete cut to fit
- VOC-compliant adhesive and gloves

Necessaries feature Rockwood Retaining Walls' multi-piece, tumbled Lakeland and Riverland wall systems. Mantels and tops are wet cast concrete from limestone originals with smooth, honed surfaces and chiseled edges.



### Affordable Luxury:

Necessaries kits are both beautiful and functional, turning backyards into attractive and enjoyable outdoor living spaces. Also, Necessaries come ready-to-assemble with everything needed for installation, making the process easier and more affordable than typical masonry structures.

### Easy to Build:

Each Necessaries Outdoor Living Kit comes complete with everything you need, including pre-cut block sized-to-fit, reinforcements, adhesive, and easy-to-read, step-by-step instructions. Most kits can be built by two people in an afternoon, or less.

### Expand Anytime:

You can build your project all at once or add new features over time. Because of Necessaries' modularity, expanding your outdoor living space is easy to do whenever you are ready.



# FIREPLACE KITS

## GRAND FIREPLACE KITS

The **Grand Fireplace Kit** is the perfect centerpiece for your outdoor living room. Its appeal comes from its large profile, universal design and aged appearance. Includes FMI Products Tuscan 36" stainless steel, wood-burning insert, log rack and spark curtain.

- 4' stainless stovepipe chimney
- Spark suppressor cap

**Optional:**

- Grand Woodbox Kit, L or R
- Grand Hearth Kit



*Silver Creek*  
STONEWORKS

Necessaries mantels, caps and tops are cast from Indiana limestone originals and have smooth, honed surfaces with hand-chiseled edges.

Fireplaces can be built with or without woodbox or hearth kits and all Necessaries kits can be customized.

Kits are not suitable for commercial installations.







**COMPACT  
FIREPLACE KITS**



**COLONIAL  
FIREPLACE KITS**



**VICTORIAN  
FIREPLACE KITS**

The **Compact** and **Colonial** Fireplace Kits are ideal for smaller backyards and patios. Each kit comes complete with 2.25" thick firebrick, ensuring durability and enhancing the overall appearance. Taller and wider, the **Victorian** Fireplace Kit becomes the focal point in any backyard. Popular for their affordability and smaller footprints, these fireplaces will generate warm accolades from family and guests for years to come.

- 2.25" fire brick for lasting protection

**Optional:**

- Hearth Kit
- Woodbox Kit, left or right side

Complete your backyard living room with seatwall and pillar kits.



**Grand Fire Ring Kit:**

- 48" dia. x 12" H (31" interior dia.)
- One-piece, heavy-gauge, solid steel insert protects block

**Optional:**

- **Fire Ring Block Layer:** adds layers to increase height
- **Fire Ring Cap:** chiseled edge, eight pieces, in three colors, 2.25" H
- **Swivel Cooking Grate:** removable, heavy steel construction, ADA compliant
- **E-Z Access Spark Screen:** keep ash and sparks inside and debris out; hinged for easy access
- **Cover:** heavy galvanized steel with or without cooking grate slot



- Optional:
- Swivel Cooking Grate
  - Steel Cover
  - E-Z Access Spark Screen

**Victorian Fire Pit Kit:**

- Four-piece, heavy-gauge steel insert protects block
- Optional Swivel Cooking Grate

Designed for slab, paver or gravel bases, the Grand Gas Fire Ring Kit has both style and convenience. Smokeless and ashless, it's an ideal alternative for properties with open burning restrictions.

**Grand Gas Fire Ring Kit:**

- Push-button electronic ignition, 65,000 max Btu/hr
- NG or LP fuel type, thermo-couple auto shut-off feature
- #304 stainless steel construction
- 50 lbs. lava rock

**Optional:**

- **Fire Ring Cap:** chiseled edge, eight pieces, in three colors, 2.25" H
- **Grand Canyon Ceramic Log Set**
- **Fire Ring Block Layer:** adds layers to increase height



Kits are not suitable for commercial installations.





# GRAND ISLAND BAR SERIES KITS

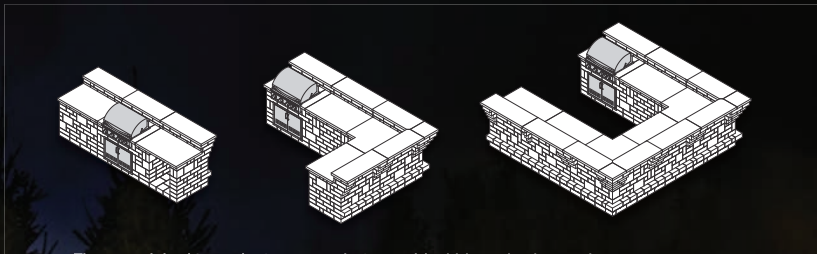

These modular kits make it easy to design and build large kitchen and entertainment areas.



Includes Summerset Pro Sizzler 32" NG or LP grill.  
Single door with grill shown no longer available.

For outdoor living enthusiasts who love cooking and entertaining, the **Grand Island Bar/Grill Series** is a wonderful addition to your home's backyard.

**a) Grand Island Bar/Grill w Storage Kit:**  
- Summerset Sizzler Pro 32" grill  
- Stainless steel double doors

**b) Grand Island Bar/Grill w Refrigerator Opening Kit:**  
- Summerset Sizzler Pro 32" grill  
- Stainless steel double doors

**c) Grand Island Bar 8' Kit**

**d) Grill Surround Kit:**  
- For standing grills, 60" opening

**e) Corner Return Kit:**  
- Makes L-shaped bar/grill

**f) Bar Section 4' Kit:**  
- Left or right facing

Grand Island Bar Series tops are 2.25" H reproductions of Indiana Limestone originals.

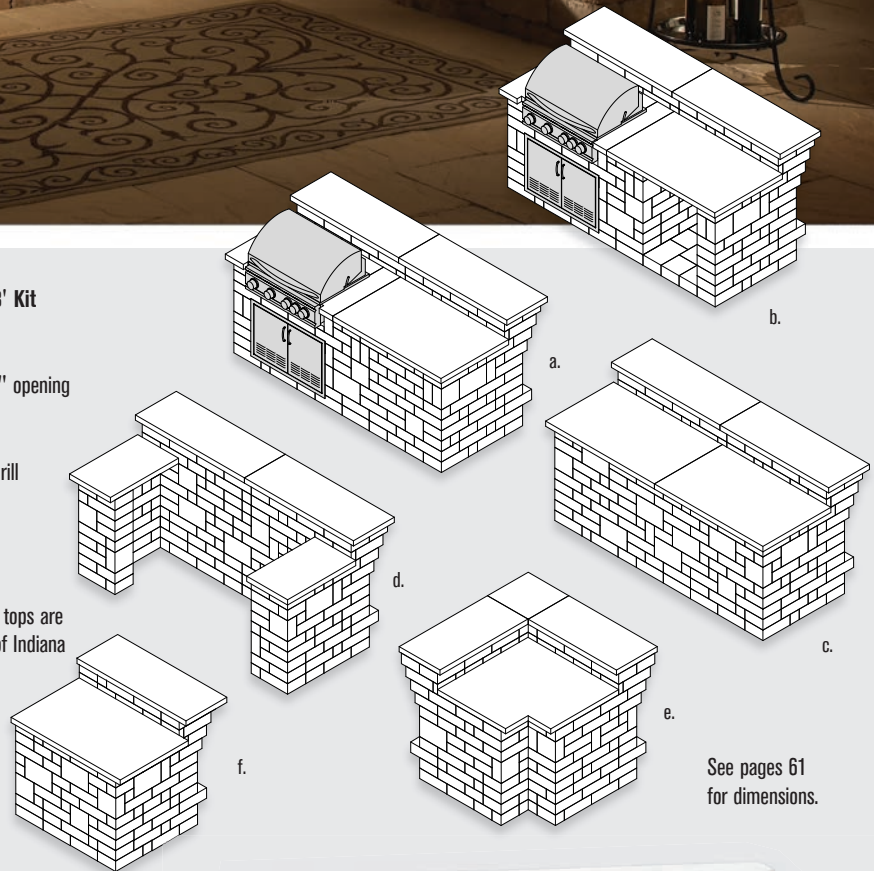

See pages 61 for dimensions.

 **SUMMERSET**

[www.summersetgrills.com](http://www.summersetgrills.com)

**Summerset Pro Sizzler Grills:**  
- #443 stainless steel construction  
- Push-to-turn knob ignition, 3" temp gauge  
- 14,000 Btu cast burners  
- 15,000 Btu infrared back burner  
- Natural gas or propane fuel  
- Double-lined hood ensures optimal airflow  
- 8mm cooking grates won't warp or rust  
- Easy-clean briquette system for even heat

- LED lit controls  
- Heat zone separators  
- Interior cooking lights  
- Requires 120 volt electrical

**Optional Deluxe Rotisserie:**  
- #304 stainless steel  
- Heavy-duty motor  
- 25 lb. capacity







## PUB/BISTRO TABLE KIT

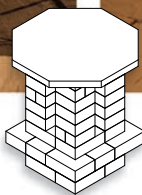
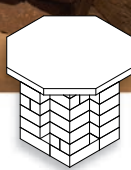

Every outdoor dining and living room should include functional and attractive furniture. These stylish Pub and Bistro Tables are the perfect size for enjoying a cold drink and summertime snacks. The hand-chiseled 36" octagon top adds a distinctive look to any outdoor area.

**Pub/Bistro Table Kit:**  
 - 42" height (Bistro 30" height)  
 - 4" foot rail



## COMPACT BAR KIT

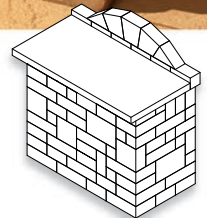
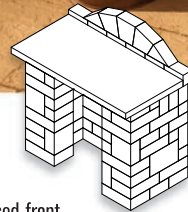

**Compact Bar Kit:**  
 - Builds open or closed front  
 - 24" D x 48" W work surface  
 - Decorative backsplash



## DINING TABLE KIT



The **Necessaries Dining Table** is easy to maintain, will never blow away in a storm and will outlast all others. The **Necessaries** table fits easily into any outdoor dining room design.

- 36" W x 96" D (top)  
 - 30" tall, dining chair height  
 - Seats eight easily





## SEATWALL KITS



Shown with optional chiseled top.



## PILLAR KITS

Waterfall kits are easy to build and essentially maintenance-free. These above-ground designs are ideal when in-ground ponds and waterfalls are not an option. Waterfall kits include all plumbing/connections. 120 volt electrical required. Catch basin stones not included.

### Grand Waterfall Kit:

- 1,350 gph mag drive pump
- 48" half-round basin
- 23" stainless steel spillway
- Optional LED light kit

### Compact Waterfall Kit:

- 850 gph mag drive pump
- 26" square basin
- 11" stainless steel spillway
- Optional LED light kit



## COMPACT WATERFALL KIT



## GRAND WATERFALL KIT

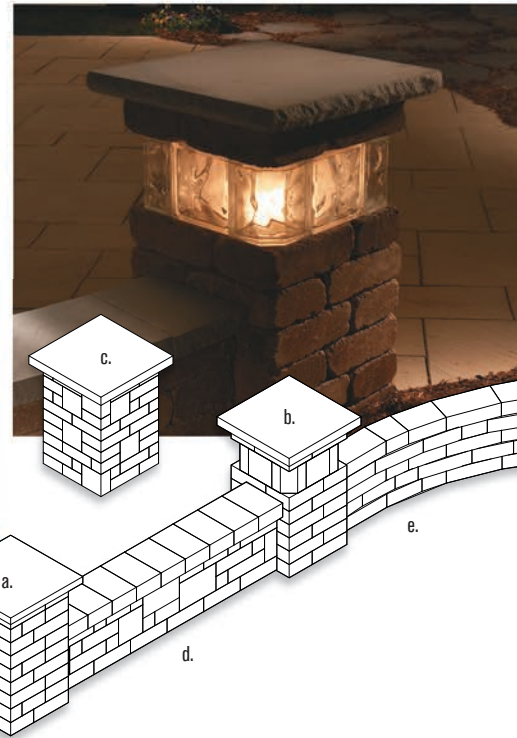

Pillars can be added to Seatwalls or built as a freestanding landscape feature, such as a property marker or light base.

### a) 20" Pillar Kit:

- 2.25" H chiseled cap

### b) 20" Pillar with Glass Kit:

- Pittsburgh Corning Premiere 8" glass block (lights not included or available)
- 2.25" H chiseled cap

### c) 24" Pillar Kit:

- 2.25" H chiseled cap

### d) Lakeland Seatwall Kit:

- Creates a 6' straight wall
- Optional chiseled cap

### e) Riverland Seatwall Kit:

- Creates an 8' radius wall
- Optional chiseled cap



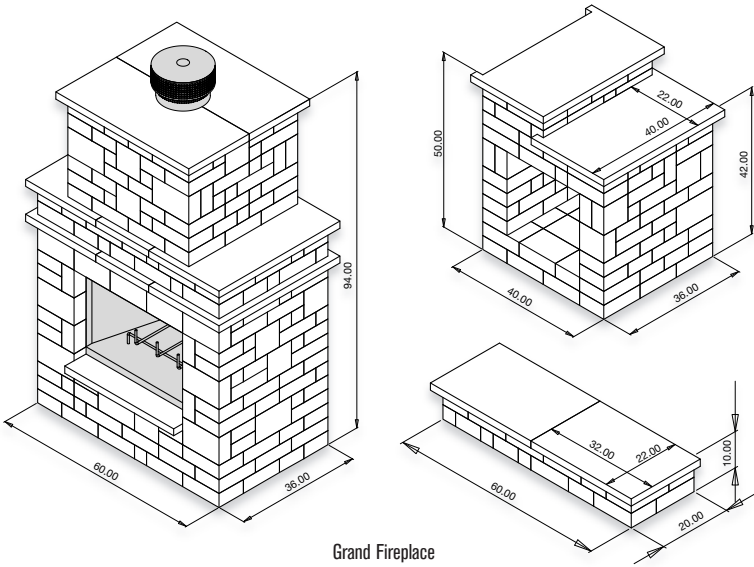

Grand Fireplace

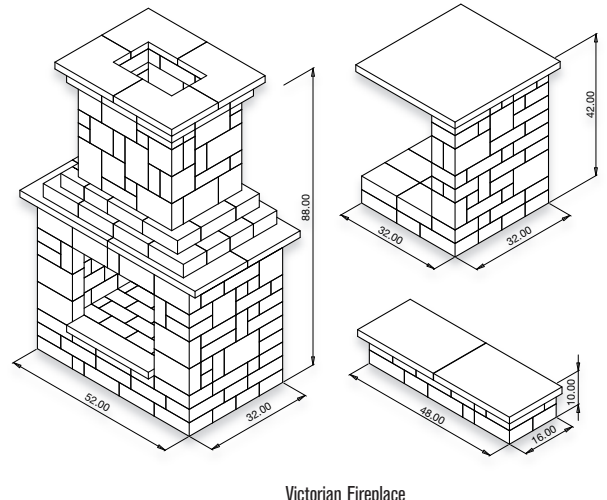

Victorian Fireplace

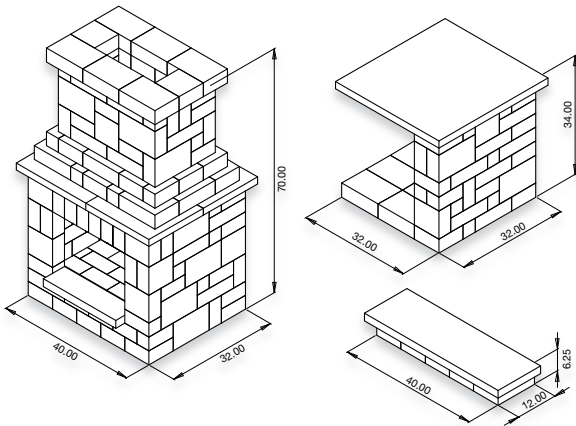

Colonial Fireplace

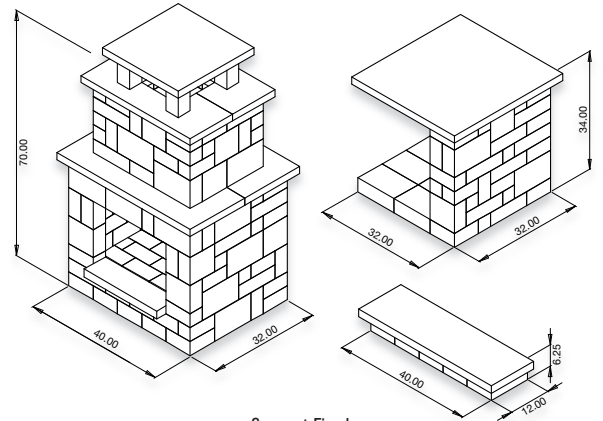

Compact Fireplace

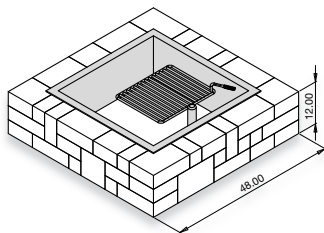

Victorian Fire Pit  
Optional cooking grate

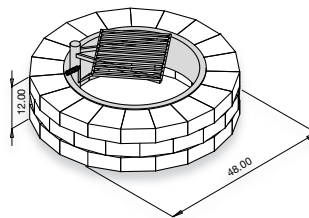

Grand Fire Ring  
Optional cooking grate

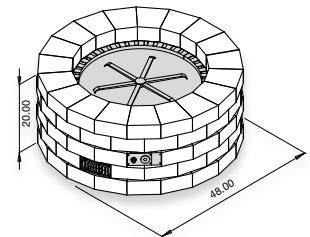

Grand Gas Fire Ring



All dimensions shown in inches. Kits are not suitable for commercial installations.

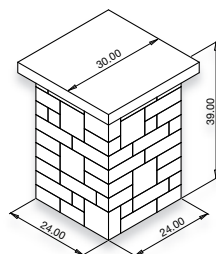

24" Pillar w/Glass

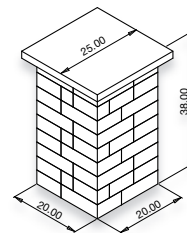

20" Pillar

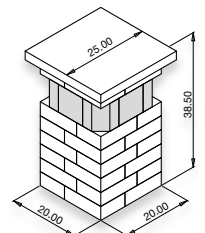

20" Pillar w/Glass



# OUTDOOR LIVING KITS



SUMMERSET

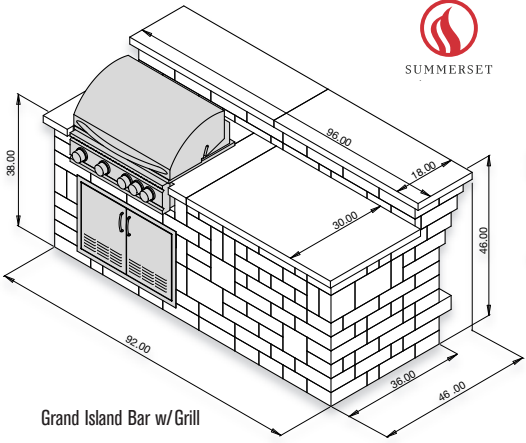

Grand Island Bar w/Grill

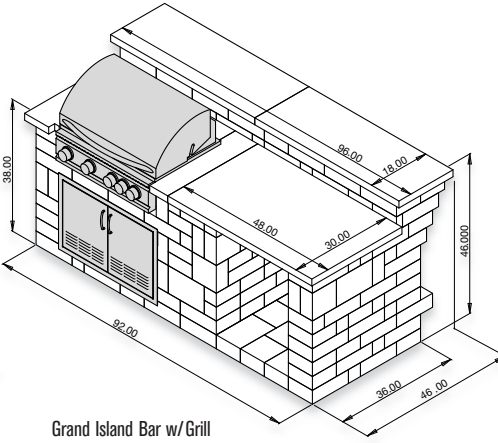

Grand Island Bar w/Grill & Refrigerator Opening

Corner Return

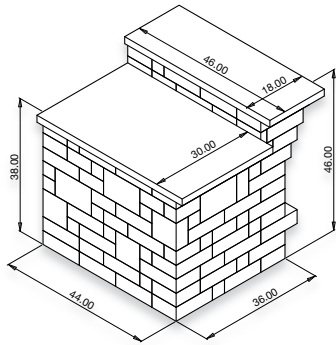
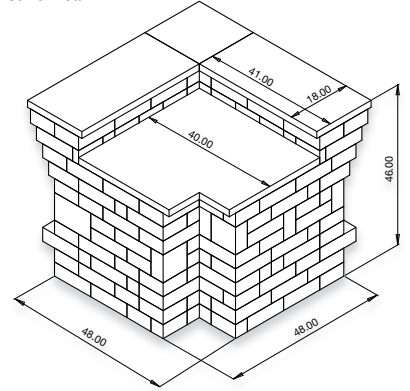

4' Bar Extension

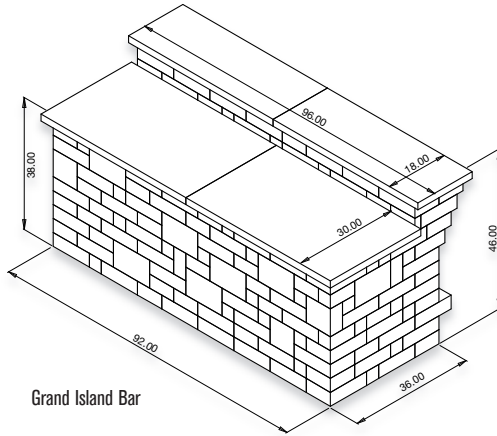

Grand Island Bar

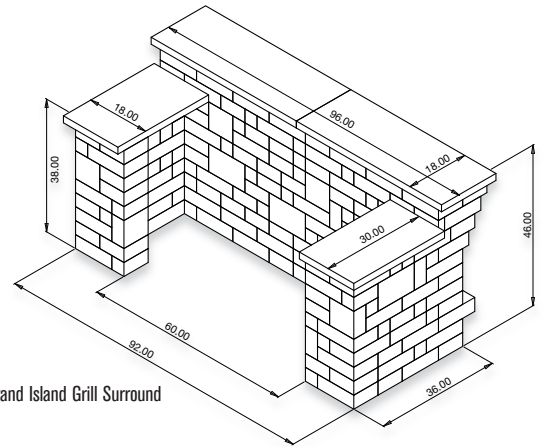

Grand Island Grill Surround

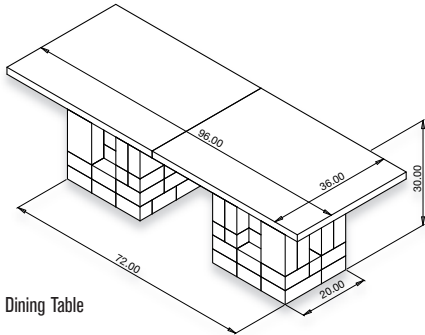

Dining Table

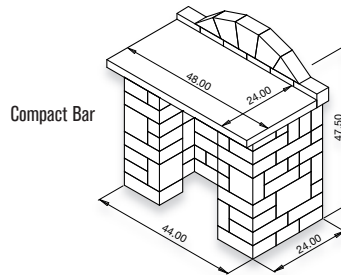

Compact Bar

Woodbox/Stand

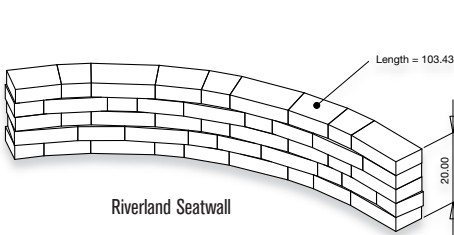
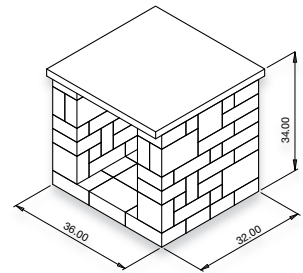

Riverland Seatwall

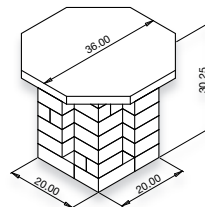
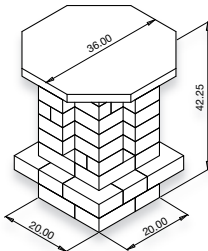

Pub/Bistro Table

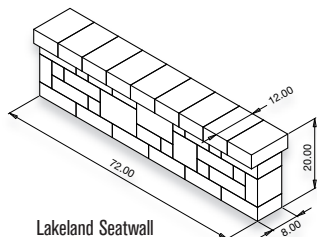

Lakeland Seatwall

Compact Waterfall

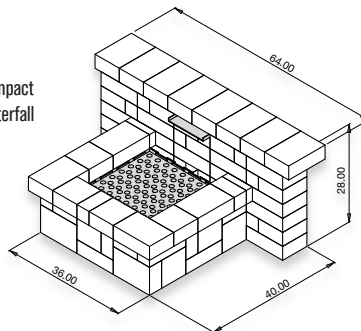

Grand Waterfall

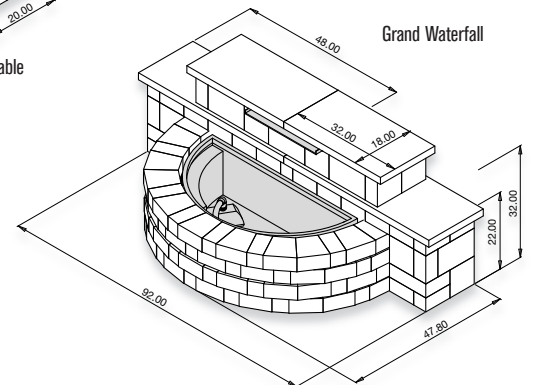



# KITCHEN

# CABINET COLLECTION



KITCHEN CABINETS ARE FOR BACKYARD BAKING, GRILLING, DINING AND ENTERTAINING. ELEGANT, FUNCTIONAL AND AFFORDABLE, THESE HIGH QUALITY KITS & COMPONENTS ARE READY TO ASSEMBLE IN ANY CONFIGURATION YOU CAN IMAGINE.



**Kitchen cabinet kits with solid granite tops:**  
 Nearly as durable as diamonds, granite owes its density and hardness to its origins – solidified under extreme pressure deep within the earth. Granite is as durable as it is beautiful; it's not affected by extremes in temperature and under normal conditions, resists etching by knives, household acids and kitchenware. Choose from two granite top colors.

**Besides its beauty, granite is:**  
 - Sanitary; when sealed, granite does not harbor bacteria  
 - Highly resistant to burning or charring from hot pans, appliances, utensils etc.  
 - 100% natural, non-toxic and easy to clean

**Earthy cabinet colors:**  
 Necessaries kits feature Rockwood Retaining Walls' multi-piece, tumbled Lakeland wall block. Its linear design and aged appearance fit well in landscapes of any style or decor. Choose from three cabinet colors.



**Kitchen kits can be ordered with or without tops.**

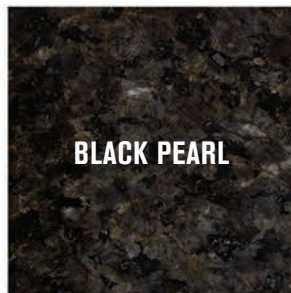



## OUTDOOR LIVING KITS

### SIZZLER PRO GRILL CABINETS



#### 32" Sizzler Pro Grill Cabinet:

- 48" W x 28" D x 37" H
- 4 main burners, 795 sq. in. cooking surface
- 56,000 max Btu's

#### 40" Sizzler Pro Grill Cabinet:

- 56" W x 28" D x 37" H
- 5 main burners, 985 sq. in. cooking surface
- 70,000 max Btu's

#### Summerset Sizzler Pro Grills:

- #443 stainless steel construction
- Push-to-turn knob ignition
- 3" temp gauge
- 14,000 Btu cast burners
- 15,000 Btu infrared back burner
- Natural gas or propane fuel
- Double-lined hood for optimal heating
- 8mm cooking grates won't warp or rust
- Easy-clean briquette system for even heat
- Exterior LED lights (120 volt electrical required)
- Heat zone separators
- Interior cooking lights
- Includes 30" double stainless doors, choice of granite/cabinet colors

#### Deluxe Rotisserie: (optional)

- #304 stainless steel
- Heavy-duty motor, 25 lb. capacity

### WOODBIX/STAND CABINET



#### Woodbox Stand Kit: (oven not available)

- 16 W x 16 D x 32" H opening (4.75 cu. ft.)
- Choice of granite/cabinet colors

 SUMMERSET

[www.summersetgrills.com](http://www.summersetgrills.com)



The **Island Cabinet Kit** is the centerpiece of your outdoor kitchen. Large enough to seat six adults, with over 28 sq. ft. of surface for prep, dining and entertaining.

- Two easy-glide stainless steel drawers and magnetic-close door
- Choice of granite and cabinet color

**Drop-in Sink: (optional)**

- 15" L x 15" W x 6" D stainless steel
- Double-handle valve stainless faucet
- Stopper/strainer

**Prep Center Cabinet Kit:**

With over 9 sq. ft. of surface, the Prep Center Cabinet will be appreciated for its generous workspace. Build it with the optional sink, and it will make your outdoor kitchen truly complete.

- Two easy-glide stainless steel drawers and magnetic close door
- Choice of granite/cabinet colors

**Drop-in Sink: (optional)**

- 15" L x 15" W x 6" D stainless steel
- Double-handle valve stainless faucet
- Stopper/strainer



# ISLAND TABLE



## REFRIGERATOR CABINET

**Refrigerator Cabinet Kit:**

- 24" W x 24" D x 36" H opening
- Choice of granite and cabinet color
- Refrigerator not available

Kits are not suitable for commercial installations.



## PREP CENTER CABINET



**Smoker Cabinet Kit:** (smoker not available)  
 - 24" W x 24" D opening for your smoker

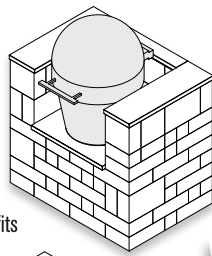

**Side Burner Cabinet Kit:**

Combine the comfort of an indoor kitchen range with all the benefits of being outside. Specially designed for performance and function, Summerset's double side burner is the perfect addition to your outdoor kitchen.

- #304 stainless steel construction
- Push-to-turn knob ignition
- 30,000 Btu/hr solid brass burners
- 19.5" x 10.5" cooking surface with stainless cover
- Two easy-glide drawers, fully enclosed exterior

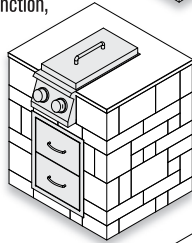

**Trash Drawer Cabinet Kit:**

- #304 stainless steel construction
- Easy-glide pullout drawer, holds 12-gallon trash can

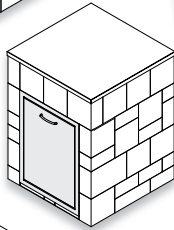

**Storage Cabinet Kit:**

- #304 stainless steel construction
- Two easy-glide drawers, fully enclosed exterior

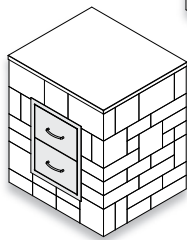

**Corner Cabinet Kit:**

- For L-shaped designs or additional space

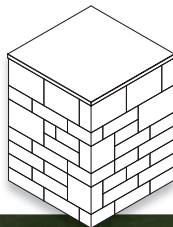

**The Kitchen Standard Features:**

- Easy-to-read, step-by-step assembly instructions
- Multi-piece Lakeland blocks in three color choices
- Solid granite tops in two color choices
- Reinforcements and concrete cut to fit
- VOC-compliant adhesive
- Protective gloves



**SMOKER CABINET**



**SIDE BURNER CABINET**



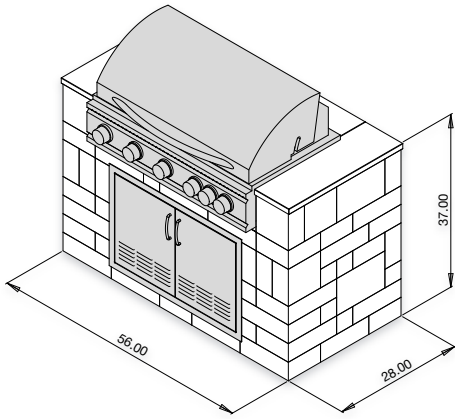

40" Sizzler Grill Cabinet

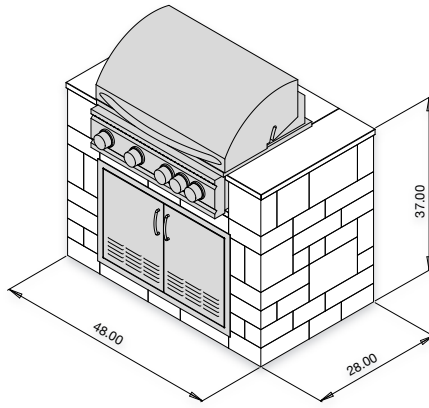

32" Sizzler Grill Cabinet

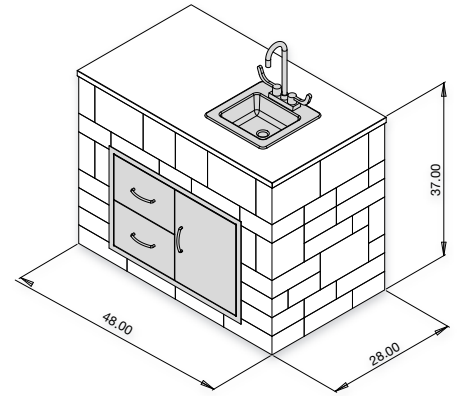

Prep Station Cabinet  
Optional sink

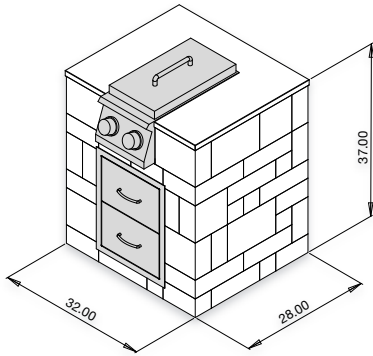

Side Burner Cabinet

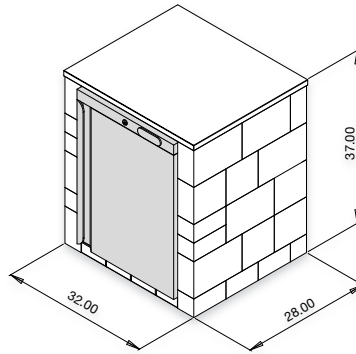

Refrigerator Cabinet

Smoker Cabinet  
Smoker not available

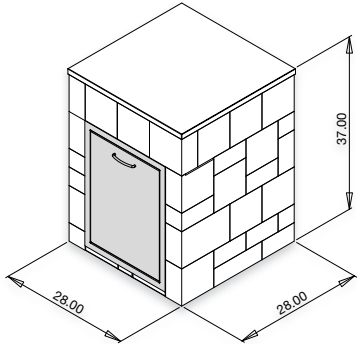
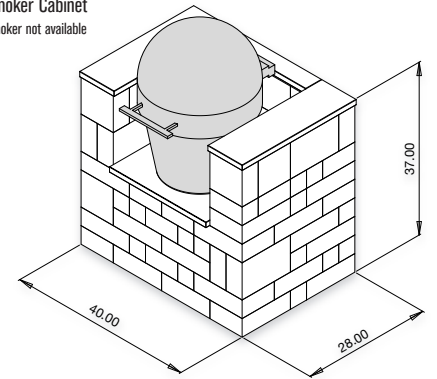

Trash Cabinet

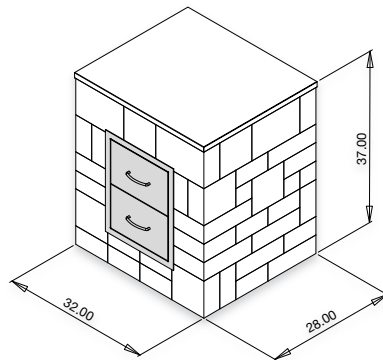

Two Drawer Cabinet

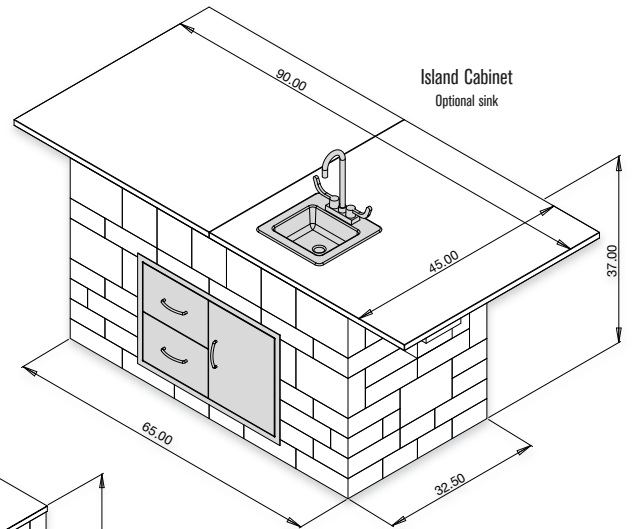

Island Cabinet  
Optional sink

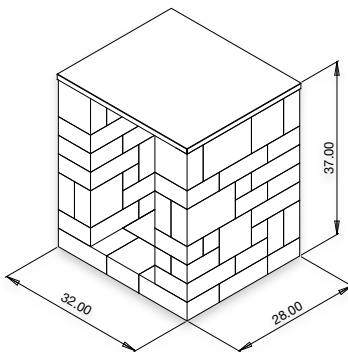

Woodbox/Stand Cabinet

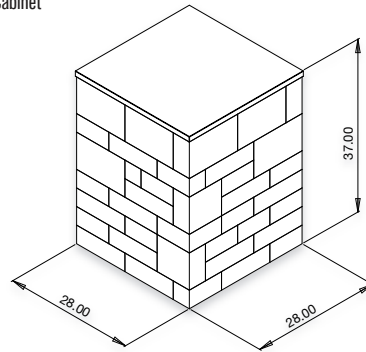

Corner Cabinet

No cutting, no guessing, no hassles - no problem!  
*necessories*  
 kits for outdoor living

**ROCKWOOD**  
 RETAINING WALLS  
 A better way.



## PROFESSIONAL GRADE SANDS, CLEANERS AND SEALERS HELP MAINTAIN YOUR PATIO, PATHWAY OR DRIVEWAYS BEAUTY INDEFINITELY.



### CHOOSE A JOINT SAND THAT STANDS UP TO THE DAMAGING EFFECTS OF FREEZE-THAW, EROSION, WEEDS AND INSECTS.

#### Choose the right joint sand the first time

Your paver project represents an investment in your home and the time you spend outdoors. Choose a high-quality polymeric joint sand to protect your investment and minimize your time spent on maintenance. Unlike conventional sands, polymeric sand remains in place, resisting erosion caused by repeated sweeping, wind, rain and even power washing.

#### Eliminate grass and weeds

Weeds and grasses will take root anywhere they can, including your new patio if not sanded properly. Polymeric sand creates an impenetrable sand joint and represents the best defense available against unwanted vegetation.

#### Insect protection

Without the proper protection, ants will take up residence in the spaces between pavers. Like weed prevention, polymeric sand forms an impenetrable barrier against ant and insect tunneling.

### LIKE ANY DECORATIVE EXTERIOR SURFACE, PAVERS AND LANDSCAPE TILES AREN'T IMMUNE TO THE EFFECTS OF TIME AND USE.

#### Keep your investment clean and beautiful

BBQ grease, motor oil, suntan lotion, fertilizer granules, bird droppings, leaf stains, paint and tire marks conspire to dull the beauty of decorative pavement. Sealing products are the optimal prevention against discoloration caused by weathering, UV rays and salt. Over time, the corrosive forces of nature can take a toll on pavers. Applying a protectant slows the march of time.

#### Make surfaces easier to clean

The time and effort required for regular cleaning or preparing to entertain is dramatically reduced if your pavement is protected. Sealers are the ultimate protection against oil and other stains.

#### Choose your look

You can choose the look of your patio, path or drive by the product used to protect its surface. A wet-look or semi-gloss sealer enhances color while matte or natural-look sealers preserve its original appearance. No matter what look you choose, sealing is the essential final step in your project.



©Copyright 2021 All Rights Reserved. Rockwood products are made under license from Rockwood Retaining Walls, Inc. US and international patents issued and pending. This information has been prepared for the benefit of customers interested in hardscaping products. It was reviewed carefully prior to publication. Mid-Atlantic Concrete Products assumes no liability for its accuracy or completeness. Final determination of the suitability of any information or material for the use contemplated, or for its manner of use, is the sole responsibility of the user. PROPOSITION 65 WARNING: These Products, the fuel used in this Products and other wood and charcoal burning appliances, and the combustion products of such fuels contain chemicals known to the State of California to cause cancer, or birth defects or other reproductive harm. 321



www.midatlanticcp.com



# WELCOME

# TO THE BACKYARD...



YOU'RE GOING TO LOVE IT OUT HERE!



**Mid-Atlantic**<sup>™</sup>  
CONCRETE PRODUCTS

2460 Armstrong Dr., Winston-Salem, NC 27103 • Phone: 336-774-6544 • Fax: 336-774-9060





# YOU'RE GOING TO LOVE IT OUT HERE!



## TILES, PAVERS & PORCELAIN

ANTIQUE TRAVERTINE LANDSCAPE TILES .....	12
BARN PLANK LANDSCAPE TILES .....	14
BELGARD PAVERS AND WALLS .....	16-21
PATIO & ROOFTOP DECKING .....	10
PORCELAIN PAVERS .....	28-31
SLATE LANDSCAPE TILES .....	6-9

## NATURAL STONE

FLAGSTONE PAVERS .....	22
TRAVERTINE PAVERS .....	24
FLAGSTONE, FIELDSTONE AND BOULDERS .....	26

## RETAINING WALLS

BARN PLANK GARDEN WALL .....	40
CLASSIC® 8 .....	44
HERITAGE BLOCK .....	38
KEYSTONE COMPAC III AND STANDARD III .....	46
PREMIER 9D COLONIAL .....	34
PREMIER 8 .....	37
PREMIER 9D .....	36
ROSETTA KODAH AND OUTCROPPING .....	42
STONELEDGE .....	32



Note: Our products are made from solid color concrete for lasting appearance and durability. Photographs contained herein are for representation only. Refer to actual product samples when making color selection. Product dimensions given are nominal.

The information presented here has been prepared for the benefit of customers interested in Mid-Atlantic Concrete Products and was reviewed carefully prior to publication. Mid-Atlantic Concrete Products assumes no liability for its accuracy or completeness. Final determination of the suitability of any information or material for the use contemplated, or for its manner of use, is the sole responsibility of the user. Product specifications, colors and availability subject to change at any time.



www.midatlanticcp.com



**Mid-Atlantic**<sup>™</sup>  
CONCRETE PRODUCTS



**OUTDOOR LIVING KITS** ..... 52

COMPACT BAR ..... 58

DINING AND PUB TABLES ..... 58

FIREPLACES ..... 54

FIRE RINGS ..... 56

GRAND ISLAND BAR SERIES ..... 57

PILLARS ..... 59

SEATWALLS ..... 59

WATERFALLS ..... 59

KIT DIMENSIONS ..... 60 and 66

**KITCHEN CABINET KITS** ..... 62

ISLAND CABINET ..... 64

REFRIGERATOR AND PREP CENTER CABINETS ..... 64

SIZZLER GRILL CABINETS ..... 63

SMOKER, SIDE BURNER, STORAGE AND CORNER CABINETS ..... 65

WOODBBOX/STAND ..... 63

**ACCESSORIES**

CHISELED CAPS & TOPS ..... 48

CHISELED STEPS ..... 53

SANDS, SEALERS AND CLEANERS (PROTECT YOUR INVESTMENT) ..... 67

WET CAST STEPS ..... 50



# WELCOME

# TO MID-ATLANTIC







WELCOME TO MID-ATLANTIC CONCRETE PRODUCTS. WE ARE THE SOUTHEAST'S LEADING MANUFACTURER AND DISTRIBUTOR OF THE HIGHEST QUALITY OUTDOOR LIVING, RETAINING WALL, LANDSCAPE TILE, NATURAL STONE AND PAVER BRANDS.

Mid-Atlantic Concrete is the preferred source of both homeowners and residential and commercial landscape contractors for our high-quality product offering, exceptional customer service and attention to detail.

Our brands include: Silver Creek Stoneworks® landscape tiles, steps, pavers, caps & tops; Belgard® pavers; Rockwood® Retaining Walls, Heritage Block™, Keystone, Rosetta and CornerStone retaining walls; Landmark porcelain pavers; natural stone; Necessaries™ Outdoor Living and Kitchen Kits and professional landscaping accessories and components.

Whether you are looking to create an outdoor living room, backyard kitchen, or a retaining wall to expand and support your landscape, this comprehensive catalog is designed to serve as your design gallery. There aren't enough pages to tell the entire story, so we invite you to see more inspirational and award-winning landscapes online at [www.midatlanticcp.com](http://www.midatlanticcp.com)



**Mid-Atlantic™**  
CONCRETE PRODUCTS

2460 Armstrong Dr., Winston-Salem, NC 27103 • Phone: 336-774-6544



# SLATE



*Silver Creek*  
STONWORKS

# LANDSCAPE TILES

SLATE'S RICH TEXTURE COMES FROM ACTUAL STONE QUARRIED IN THE NORTHEASTERN U.S., WHERE STONE CRAFTSMANSHIP DATES BACK TO COLONIAL AMERICA.



# SLATE LANDSCAPE TILES



Refer to actual product samples when making color selection.



**Slate Landscape Tiles** have the look of hand-split quarried stone, their chiseled edges are ideal for treads, tops and caps. For use on paths, patios and pool decks.

- Lays quickly, patterned or random
- Unique 24" x 36" XL slab
- Gap tiles 1/4" or more

**Separate Pallets:**

- 12" W x 12" D x 1.5" H
- 12" W x 24" D x 1.5" H
- 24" W x 24" D x 1.5" H
- 24" W x 36" D x 1.5" H (XL)
- 14" W x 14" D x 1.5" H (bullnose unit)





SILVER CREEKS STONEWORKS' LANDSCAPE PRODUCTS ARE STRONG (10,000 PSI) WET CAST REPRODUCTIONS OF HANDCRAFTED ORIGINALS. THESE MANUFACTURED LANDSCAPE PRODUCTS LOOK AND FEEL LIKE THE REAL THING AND ALL ARE BACKED BY A LIMITED LIFETIME WARRANTY.



SEE COMPLETE WARRANTY AT:  
[WWW.SILVERCREEKSW.COM](http://WWW.SILVERCREEKSW.COM)





Mid-Atlantic  
CONCRETE PRODUCTS

Slate's chiseled edge detail and bullnose tiles are perfect for step treads, pool coping and tops.





# PATIO DECKING

## WITH CONCRETE

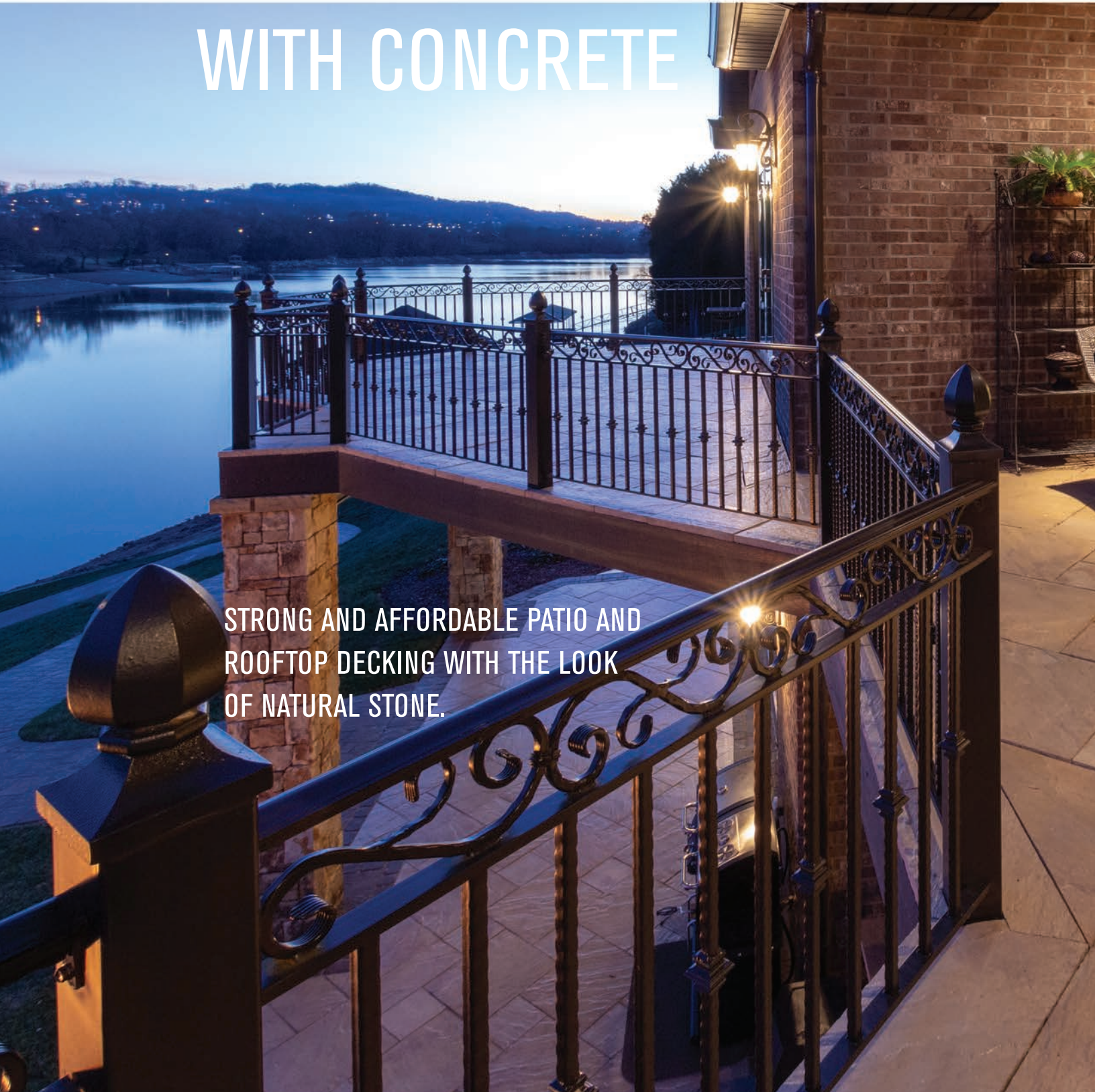

STRONG AND AFFORDABLE PATIO AND  
ROOFTOP DECKING WITH THE LOOK  
OF NATURAL STONE.



# PATIO DECKING



*Silver Creek*  
STONEWORKS



Silver Creek landscape tiles are the newest material choice for patio decking. Property owners will not only enjoy the look and feel of natural stone on their raised patio, they'll never have to scrape, paint, or stain a conventional wood deck again.

Aside from creating valuable and attractive outdoor spaces, rooftop pedestal decks have many benefits. These unique systems can promote energy efficiency, protect membrane roofing, help reduce noise, hide drainage and utilities, and allow easy access to what's below.

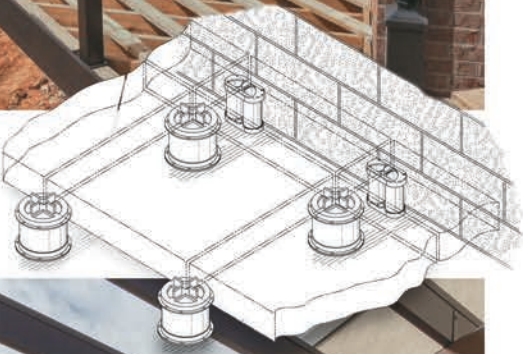

Always consult a structural engineer for proper deck design.





# TRAVERTINE

## LANDSCAPE TILES



CAST FROM MASTERS QUARRIED IN TIVOLI, ITALY – THE RENOWNED ORIGINAL IS FOUND ON FAMOUS LANDMARKS SUCH AS THE ROMAN COLOSSEUM, ST. PETER'S BASILICA, THE GETTY CENTER AND LINCOLN CENTER.



# ANTIQUe TRAVERTINE LANDSCAPE TILES



*Silver Creek*  
STONWORKS

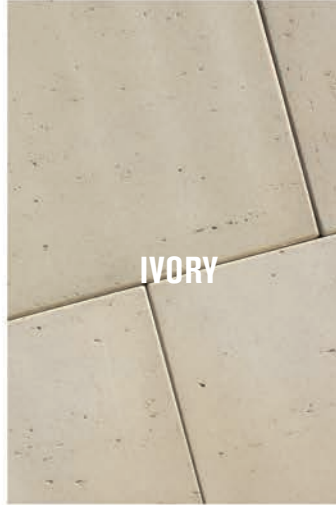

IVORY

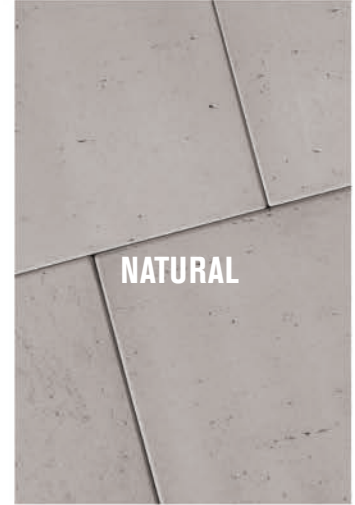

NATURAL

Refer to actual product samples when making color selection.



**Antique Travertine Landscape Tiles'** smooth, honed surface is so authentic, only you'd know they are man-made. A truly timeless look for paths, patios and pool decks. Gap tiles 1/4" or more.

**Sizes Palletized Separately:**

- 12" W x 24" D x 2" H
- 18" W x 24" D x 2" H
- 24" W x 24" D x 2" H
- 12" W x 24" D x 2" H (coping unit)



# BARN PLANK

## LANDSCAPE TILES

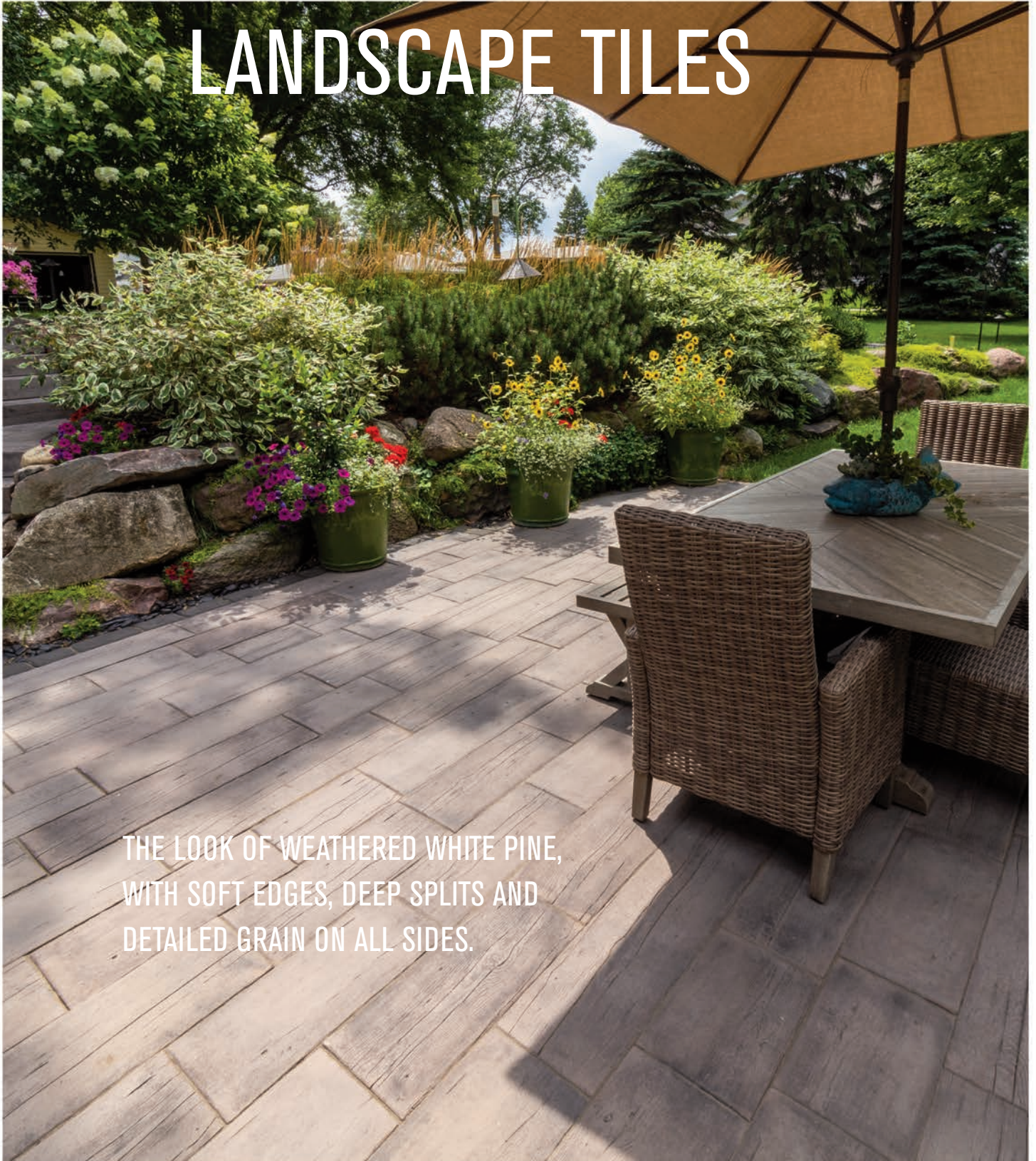

THE LOOK OF WEATHERED WHITE PINE,  
WITH SOFT EDGES, DEEP SPLITS AND  
DETAILED GRAIN ON ALL SIDES.



# BARN PLANK LANDSCAPE TILES



*Silver Creek*  
STONEWORKS



**WEATHERED GRAY**

GRAY/BLACK



**MAHOGANY**

BROWN/BLACK

Refer to actual product samples when making color selection.



**Barn Plank Landscape Tiles** are manufactured with a surface-applied protectant to help resist the harmful effects of time, Mother Nature, acid rain and stains. Unlike cut lumber, these will never warp, splinter or rot.

- Deep splits, detailed grain top & sides
- For paths, patios, pools and overlays
- Matching Step and Garden Wall block
- Gap tiles 1/4" or more

**Separate Pallets:**

- 15.5" W x 9.75" D x 2" H
- 23.37" W x 9.75" D x 2" H
- 35" W x 9.75" D x 2" H





SEE ALL OUR BELGARD PAVER  
AND WALL PRODUCTS

at: [www.midatlanticcp.com](http://www.midatlanticcp.com)

# BELGARD

## PAVERS



SINCE 1995, BELGARD HAS SET THE STANDARD  
FOR INNOVATIVE AND QUALITY OUTDOOR  
HARDSCAPES WITH ITS INTERLOCKING  
CONCRETE PAVERS.



# BELGARD PAVERS





PAVERS AND SLABS

YOUR LOCAL PROFESSIONAL WILL  
HELP FIND THE RIGHT PRODUCTS  
FOR YOUR BACKYARD.

# BELGARD

## PAVERS







Mid-Atlantic  
CONCRETE PRODUCTS



# BELGARD



## WALLS & PAVERS





BELGARD PAVERS & WALLS





# FLAGSTONE

## PAVERS



EACH FLAGSTONE IS DISTINCT, WITH UNIQUE AND VARYING COLOR PALETTES, DIFFERING RIVEN SURFACES, NATURAL VEINING AND OCCASIONAL FOSSIL PRINTS.



# NATURAL STONE



Quarried and calibrated natural flagstone (nominal dimensions).

- 12" W x 12" D x 1.2" H
- 24" W x 12" D x 1.2" H
- 24" W x 24" D x 1.2" H
- 24" W x 36" D x 1.2" H

Refer to actual product samples when making color selection.





THESE QUARRIED PAVERS  
ARE AS AFFORDABLE AS  
THEY ARE BEAUTIFUL.

# TRAVERTINE

## PAVERS





# NATURAL STONE

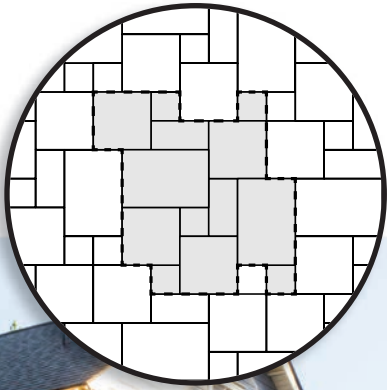

These extremely popular and affordable quarried, natural travertine tiles are calibrated and surface polished. Each pallet has 176 sq. ft. and is designed to be installed in a French pattern. Matching 24" W x 12" D full bullnose for coping and treads.

- 8" W x 8" D x 1.25" H
- 8" W x 16" D x 1.25" H
- 16" W x 16" D x 1.25" H
- 16" W x 24" D x 1.25" H

Refer to actual product samples when making color selection.



Mid-Atlantic™  
CONCRETE PRODUCTS



# NATURAL FIELD AND FLAGSTONE



## Pier Caps

- 24 X 24 x 2" H
- Natural Stone, finished all sides



## Wall Caps

- 24 X 24 x 2" H
- Natural Stone, finished three sides
- Buff or Gray Castle colors



## Step Blocks

- 48 X 16 x 6"
- Natural Stone, finished all sides
- Buff or Gray Castle colors



# NATURAL STONE

We inventory an extensive selection of quarried Tennessee flagstone and fieldstone for construction and landscape contractors.



**STEPPERS**



**FIRE BOULDERS**



**LANDSCAPE BOULDERS**



**GRAY FLAGSTONE**



**THIN STACKED FLAGSTONE**

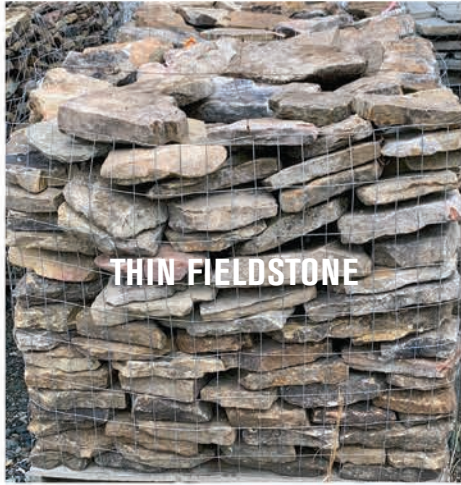

**THIN FIELDSTONE**



**TAN FLAGSTONE**



**MEDIUM STACKED FLAGSTONE**



**MEDIUM FIELDSTONE**



# PORCELAIN PAVERS

## PORCELAIN PAVERS VS. OTHER OUTDOOR PAVING MATERIALS

Features	Frontier20 Porcelain Pavers	Wood Pavers	Clay Brick	Concrete (CIP) Cast In Place	Concrete Pavers	Natural Stone
Stainable	No	Yes	Yes (Highly)	Yes	Yes	Yes (Highly)
Freeze/Thaw Proof	Yes	No	No	No	No	No
Salt Resistant	Yes	No	Salt will Degrade	No	No	No
Acid Resistant	Yes	No	Acid will Burn	No	No	No
Scratch Resistant	Highly	No	Somewhat	No	No	No
Moisture Absorption	< 0.5%	Highly Varied	5%	5%	5-10%	> = 5%
Easy-to-Repair	Yes	Yes	No	Can Not	No	No
UV Resistant	Unaffected	No	Yes if Sealed	Yes	No	Unaffected
Needs Sealing	Never	Yes	Recommended	Recommended	Recommended	Recommended
Pressure Washer Safe	> 1500 PSI	No	Not Recommended	> 1500 PSI	No	No
Environmentally Friendly	Facility 98% Green	Many Exotic Rainforest Species	No	Large Carbon Foot Print	Possible Fly Ash Content	Mined or Imported
Recycled Content	20% In Each Paver	No	Not Possible	Not Possible	If Possible Less than 5%	Not Possible

### GRIP FINISH (9MM)

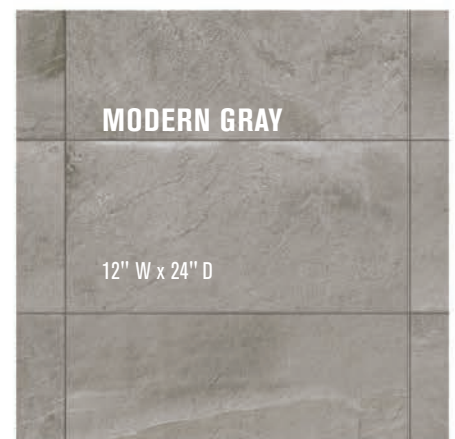
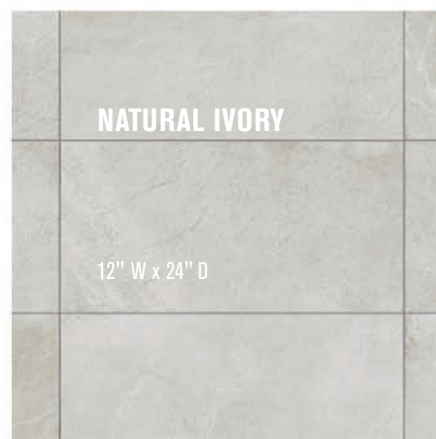



# FRONTIER20 PORCELAIN PAVERS



Frontier20 are porcelain pavers designed and manufactured to withstand decades of exposure to destructive conditions from wear, Mother Nature, chemicals and freeze/thaw cycles that can destroy some composite, wooden and concrete products. These stain-proof, slip-resistant, chemical-resistant, no-maintenance porcelain tiles can be installed using a traditional mortared bed, a sand/limestone set or as an elevated deck or pedestal application and can be utilized in a eco-friendly permeable application.

- Slip-resistant, waterproof, stain-proof, scratch/dent-resistant, fire-resistant
- Outdoor/indoor friendly
- Easy to clean
- Tiles are 20mm or .787" tall
- Grip-finish floor, wall and countertop tiles are 9mm tall
- Matching trim, tread, coping, drain, riser and corner units

Refer to actual product samples when making color selection.

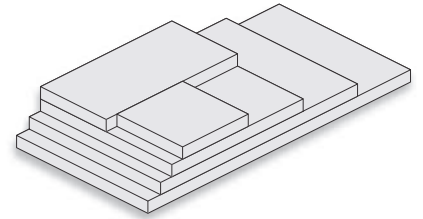

## CONCRETE LOOK (20MM)

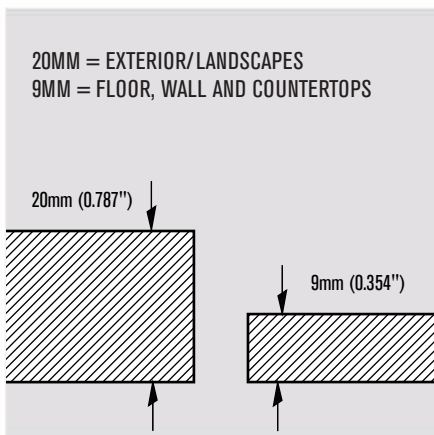
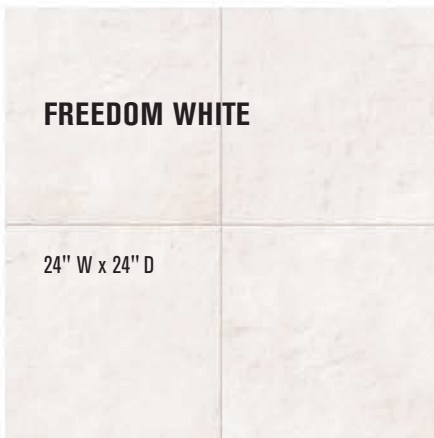





**TRAVERTINE LOOK (20MM)**



**BLUESTONE LOOK (20MM)**





# FRONTIER20 PORCELAIN PAVERS



CREATED FOR OUTDOOR USE, THESE TILES ARE INHERENTLY SLIP RESISTANT AND IMPERVIOUS TO CHEMICALS, SALT, FADING, OR SCRATCHING.

## WOOD LOOK (20MM)

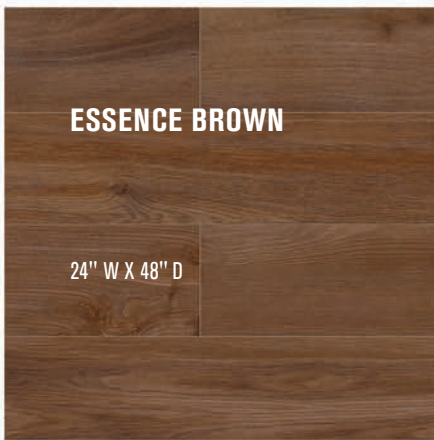

## STONE LOOK (20MM)

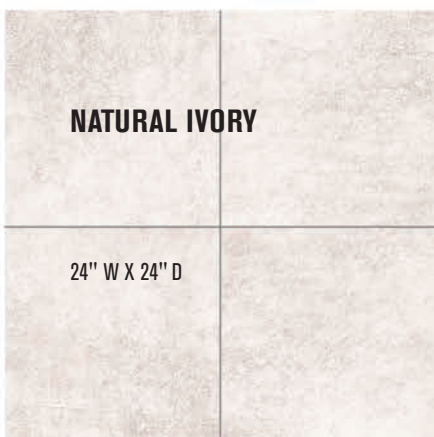



# STONEEDGE

## RETAINING WALL



STONEEDGE BLOCKS ARE DOUBLE-SIDED AND CAN EASILY BUILD FREE-STANDING SEATWALLS, PILLARS AND RETAINING WALLS.



# STONELEDGE RETAINING WALL

Created as a multi-sized, double-sided, tapered unit, **StoneLedge** creates the hand-finished look of quarried stone, perfect for creative residential or commercial projects. F lag connectors on each block create strong, vertical or 4.5 setback retaining walls.

## StoneLedge Wall Blocks:

- 18/18" W x 10" D x 6" H
- 12/9" W x 10" D x 6" H
- 6/3" W x 10" D x 6" H
- 14/12" W x 12.5" D x 3" H (cap)
- 18" W x 9" D x 6" H (corner)

TUMBLED





# PREMIER 9D

## COLONIAL WALL

PREMIER 9D COLONIAL HAS A DISTINCTIVE LOOK  
THAT APPEALS TO BOTH RESIDENTIAL AND  
COMMERCIAL PROPERTY OWNERS.



# PREMIER 9D COLONIAL RETAINING WALL

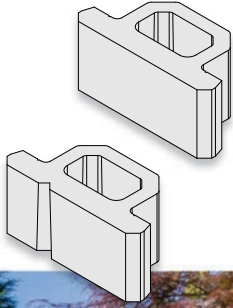

- Premier 9D Colonial Blocks:**
- 18" W x 9" D x 8" H
  - 7" setback
  - Matching cap block





# PREMIER RETAINING WALLS



PREMIER 9D IS THE CHOICE FOR LARGE PROJECTS WHERE PERFORMANCE, COST AND EFFICIENCY ARE CRITICAL CONSIDERATIONS.

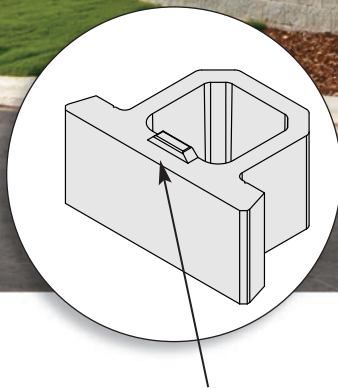

The anchor bar under each block creates an automatic 1" setback. When built, its gravel-filled cores create vertical "stone columns" that produce a multi-point interlock for a more uniform block-to-block connection.

Premier's patented, lightweight design beats all other block systems for strength, performance, freight efficiencies and ease of construction.

**Premier 9D** is the lightest weight retaining wall unit per square foot. in the industry and is one of the most cost-effective systems available.

- 18" W x 9" D x 8" H
- 49 lbs.
- 7" setback
- Matching cap block

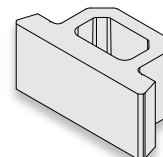



# PREMIER RETAINING WALLS

Just like Rockwood's Premier 9D, **Premier 8** retaining wall blocks are straight split-face units designed for serious performance, lightweight economics and versatility.

- 18" W x 12" D x 8" H
- 54 lbs.
- 7" setback
- Matching cap block

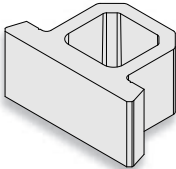

**BROWN**

West only



**DESERT TAN**

East only



**GRAY**

East and West





# HERITAGE BLOCK

## WALLS



HERITAGE BLOCK COMBINES THE DESIRABLE LOOK OF NATURAL STONE WITH THE ADVANTAGES OF SOLID PERFORMANCE.



Garden Wall Fire Pit Kit (gas version not available)

### Garden Wall Blocks:

Five-block system builds vertical walls without pins, clips or rear lip.

- 12/8" W x 7.5" D x 4" H
- 16" W x 10" D x 1" H (cap)





# HERITAGE BLOCK RETAINING WALLS



Demanding retaining walls don't have to sacrifice great looks for high performance. Heritage Block walls combine the desirable look of natural stone with the advantages of segmental concrete.

**Heritage Wall Blocks:**

- 16/12" W x 17" D x 6" H
- 24/17" W x 17" D x 6" H
- 24" W x 16" D x 6" H (2 sided)
- 24" W x 16" D x 6" H (3 sided)
- 25" W x 21" D x 1.5" H (cap)

Refer to actual product samples when making color selection.





# BARN PLANK



Silver Creek®  
STONEWORKS

## GARDEN WALL



THE LOOK OF RECLAIMED WOODEN BEAMS  
IN STRONG, WET CAST CONCRETE.



- Barn Plank Wall:**
- Detailed grain and color on five sides
  - 162 lbs.
  - 40" W x 8" D x 6" H



# BARN PLANK GARDEN WALL



- Barn Plank Step:**
- 48" W x 18" D x 5.75" H
  - 450 lbs.
  - Mahogany or Weathered Gray

- Barn Plank Fire Pit Kit:**
- Four-piece heavy gauge steel insert protects block
  - Optional, removable swivel cooking grate





# ROSETTA

## WALLS



### KODAH WALL

**Kodah Wall** blocks are strong and versatile, two-sided wet cast blocks. For use as garden walls, freestanding vertical retaining walls, seatwalls and planters.

- Four sizes on one pallet
- 12", 21", 30" and 42" lengths x 10.5" D x 6" H
- 21" W x 10.5" D x 6" H (corner)





# ROSETTA RETAINING WALLS



**Outcropping Walls** are strong, wet cast retaining wall blocks designed for serious performance and maximum curb appeal.

- 14 unique shapes on multiple pallets
- 6, 12", 18" and 24" heights x 24" to 72" widths
- 30 x 48" x 12" H (corner)
- 15 setback
- Lifting device required





# CLASSIC 8

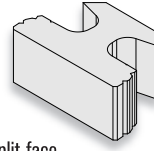

Straight-split face

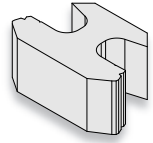

Beveled split face

## RETAINING WALL

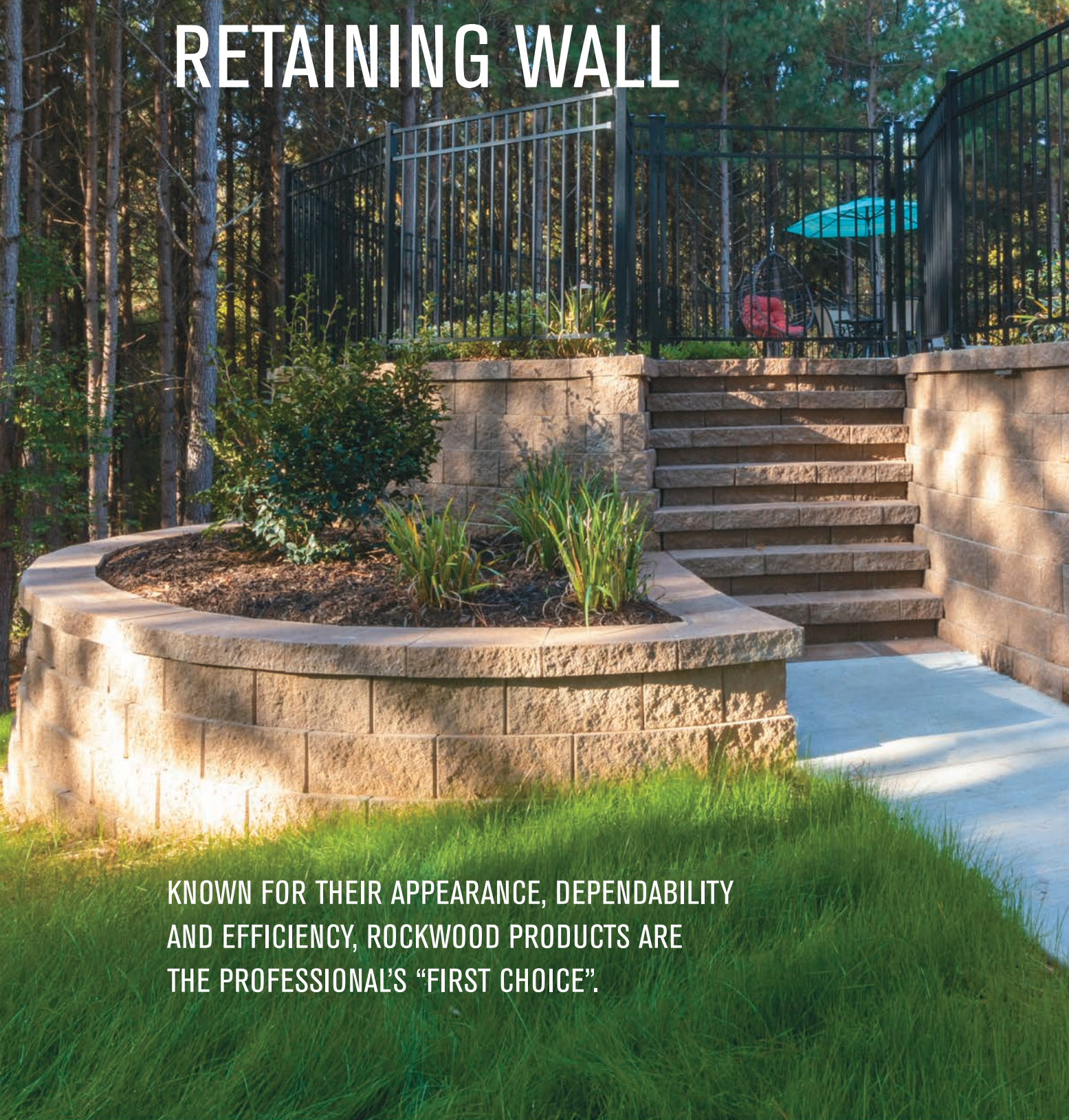

KNOWN FOR THEIR APPEARANCE, DEPENDABILITY AND EFFICIENCY, ROCKWOOD PRODUCTS ARE THE PROFESSIONAL'S "FIRST CHOICE".



**ROCKWOOD®**  
 RETAINING WALLS  
*A better way.™*

**CLASSIC 8 RETAINING WALL**



Special order



West only



East only



East and West

Appealing to homeowners, contractors and designers alike, **Classic 8** is as attractive as it is versatile. Capable of sharp radius turns, variable setbacks and endless design possibilities. **Classic 8** is perfect for any retaining wall project, no matter how large or how small.

- 18" W x 12" D x 8" H
- 7" setback
- Beveled or straight face
- Matching cap block

Refer to actual product samples when making color selection.





Standard and Compac wall blocks  
require two non-shoulder pins per unit.



# KEYSTONE

# RETAINING WALLS







# KEYSTONE RETAINING WALLS

Known for its cost savings, versatility and proven wall performance, **Compac III** features a lighter weight and shorter tail design that makes it easy to handle.

- 18" W x 12" D x 8" H (1" or 8" setback)
- 18" W x 9" D x 8" H (corner block)

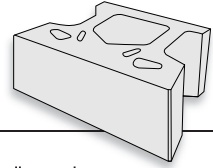

The **Keystone Standard III** unit's height-to-depth ratio delivers a structurally sound, engineered wall system with superior construction stability, durability, and strength.

- 18" W x 21" D x 8" H (1" or 8" setback)
- Tri-plane split (special order)







*Silver Creek*  
STONEWORKS

# CHISELED

# CAPS AND TOPS

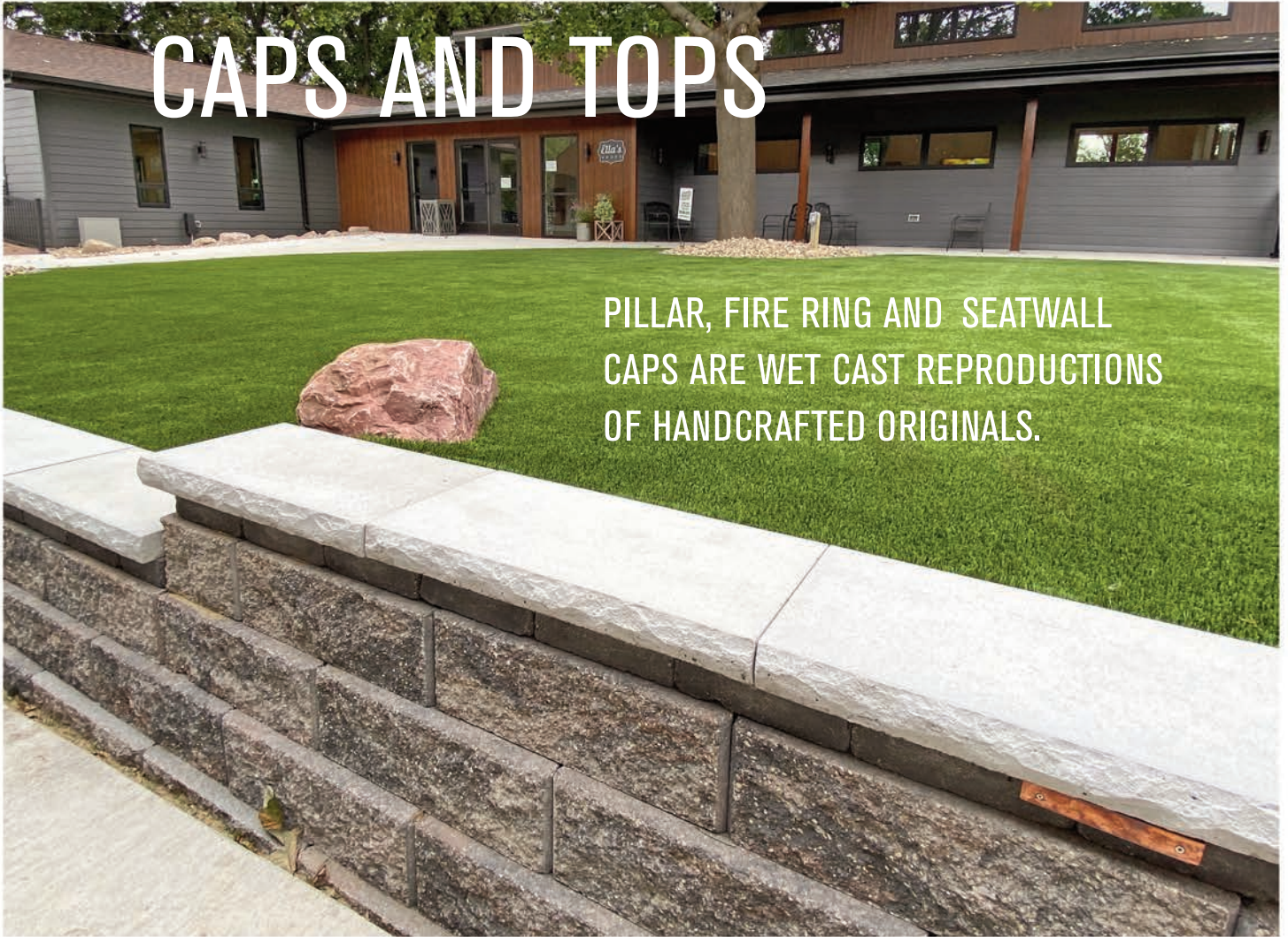

PILLAR, FIRE RING AND SEATWALL  
CAPS ARE WET CAST REPRODUCTIONS  
OF HANDCRAFTED ORIGINALS.





# CHISELED CAPS

## INDIANA LIMESTONE



## BUFF



## BLUESTONE

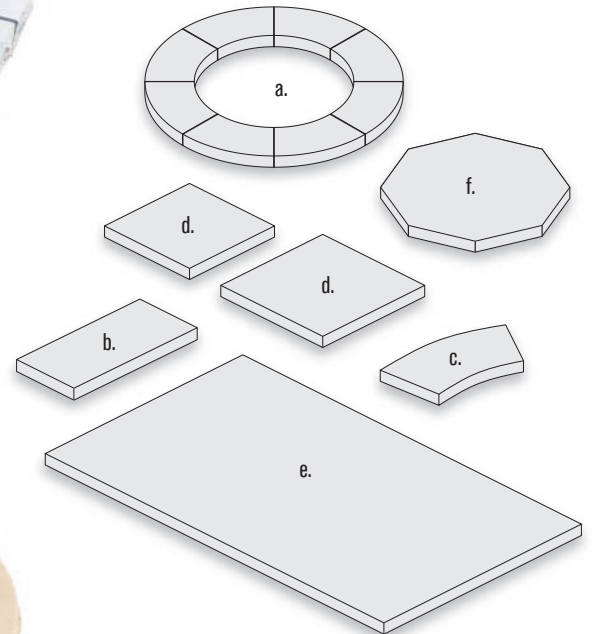

**Caps and Tops** have the look of handcrafted limestone with hewn tops and chiseled sides. Use for pillars, seat/retaining walls, fire rings and custom outdoor features.

**a) Fire Ring Caps:**  
 - Chiseled outside edge  
 - 8 pieces/set  
 - 10" D x 2.25" H

**b) Straight Wall Caps:**  
 - Chiseled two sides  
 - 24" W x 12" D x 2.25" H

**c) Radius Wall Caps:**  
 - Chiseled two sides  
 - 18.75" W x 12" D x 2.25" H

**d) Pillar Caps:**  
 - Chiseled four sides  
 - 25" W x 25" D x 2.25" H  
 - 30" W x 30" D x 2.25" H

**e) Bar Tops:**  
 - Choose from chiseled front and back, or chiseled three sides  
 - 36" W x 48" D x 2.25" H  
 - Indiana Limestone only

**f) Octagon Top:**  
 - Chiseled edge  
 - 36" W x 36" D x 2.25" H  
 - Indiana Limestone only

Refer to actual product samples when making color selection.



# WET CAST

# STEPS

SILVER CREEK STEPS ARE STRONG,  
WET CAST REPRODUCTIONS OF  
HANDCRAFTED ORIGINALS.



**Barn Plank Steps** look just like reclaimed pine beams with detailed splits and grain on tops and sides.

- 48" W x 18" D x 5.75" H (450 lbs.)
- Matching landscape tiles and garden wall blocks



MAHOGANY

WEATHERED GRAY



# WET CAST STEPS



BLUESTONE



BUFF

**Chiseled Steps** are heavy, wet cast units with the look of handcrafted limestone in two styles.

- 48" W x 18" D x 5.75" H (450 lbs.)
- Chiseled riser with smooth top and sides
- Chiseled three sides with rough top



INDIANA Limestone

Chiseled three sides, rough top.

Chiseled face, smooth top and sides.





# NECESSARIES™

## OUTDOOR LIVING KITS



No cutting, no guessing, no hassles – no problem®  
*necessaries*  
kits for outdoor living

**ROCKWOOD**  
RETAINING WALLS  
*A better way.*

[www.outdoorlivingkits.com](http://www.outdoorlivingkits.com)



# NECESSARIES IS A COLLECTION OF AFFORDABLE, READY-TO-ASSEMBLE KITS FOR OUTDOOR FIREPLACES, ISLAND BARS AND GRILLS, TABLES, WATERFALLS, FIRE RINGS, SEATWALLS AND PILLARS.



### Necessaries Standard Features:

- Easy-to-read, step-by-step instructions
- Rockwood's multi-piece Lakeland & Riverland blocks
- Reinforcements and concrete cut to fit
- VOC-compliant adhesive and gloves

Necessaries feature Rockwood Retaining Walls' multi-piece, tumbled Lakeland and Riverland wall systems. Mantels and tops are wet cast concrete from limestone originals with smooth, honed surfaces and chiseled edges.



**BEECHWOOD**



**BLUESTONE**



**SANTA FE**

### Affordable Luxury:

Necessaries kits are both beautiful and functional, turning backyards into attractive and enjoyable outdoor living spaces. Also, Necessaries come ready-to-assemble with everything needed for installation, making the process easier and more affordable than typical masonry structures.

### Easy to Build:

Each Necessaries Outdoor Living Kit comes complete with everything you need, including pre-cut block sized-to-fit, reinforcements, adhesive, and easy-to-read, step-by-step instructions. Most kits can be built by two people in an afternoon, or less.

### Expand Anytime:

You can build your project all at once or add new features over time. Because of Necessaries' modularity, expanding your outdoor living space is easy to do whenever you are ready.



# FIREPLACE KITS

## GRAND FIREPLACE KITS

The **Grand Fireplace Kit** is the perfect centerpiece for your outdoor living room. Its appeal comes from its large profile, universal design and aged appearance. Includes FMI Products Tuscan 36" stainless steel, wood-burning insert, log rack and spark curtain.

- 4' stainless stovepipe chimney
- Spark suppressor cap

**Optional:**

- Grand Woodbox Kit, L or R
- Grand Hearth Kit



*Silver Creek*  
STONEWORKS

Necessaries mantels, caps and tops are cast from Indiana limestone originals and have smooth, honed surfaces with hand-chiseled edges.

Fireplaces can be built with or without woodbox or hearth kits and all Necessaries kits can be customized.

Kits are not suitable for commercial installations.







**COMPACT  
FIREPLACE KITS**



**COLONIAL  
FIREPLACE KITS**



**VICTORIAN  
FIREPLACE KITS**

The **Compact** and **Colonial** Fireplace Kits are ideal for smaller backyards and patios. Each kit comes complete with 2.25" thick firebrick, ensuring durability and enhancing the overall appearance. Taller and wider, the **Victorian** Fireplace Kit becomes the focal point in any backyard. Popular for their affordability and smaller footprints, these fireplaces will generate warm accolades from family and guests for years to come.

- 2.25" fire brick for lasting protection

**Optional:**

- Hearth Kit
- Woodbox Kit, left or right side

Complete your backyard living room with seatwall and pillar kits.



**Grand Fire Ring Kit:**

- 48" dia. x 12" H (31" interior dia.)
- One-piece, heavy-gauge, solid steel insert protects block

**Optional:**

- **Fire Ring Block Layer:** adds layers to increase height
- **Fire Ring Cap:** chiseled edge, eight pieces, in three colors, 2.25" H
- **Swivel Cooking Grate:** removable, heavy steel construction, ADA compliant
- **E-Z Access Spark Screen:** keep ash and sparks inside and debris out; hinged for easy access
- **Cover:** heavy galvanized steel with or without cooking grate slot



- Optional:
- Swivel Cooking Grate
  - Steel Cover
  - E-Z Access Spark Screen

**Victorian Fire Pit Kit:**

- Four-piece, heavy-gauge steel insert protects block
- Optional Swivel Cooking Grate

Designed for slab, paver or gravel bases, the Grand Gas Fire Ring Kit has both style and convenience. Smokeless and ashless, it's an ideal alternative for properties with open burning restrictions.

**Grand Gas Fire Ring Kit:**

- Push-button electronic ignition, 65,000 max Btu/hr
- NG or LP fuel type, thermo-couple auto shut-off feature
- #304 stainless steel construction
- 50 lbs. lava rock

**Optional:**

- **Fire Ring Cap:** chiseled edge, eight pieces, in three colors, 2.25" H
- **Grand Canyon Ceramic Log Set**
- **Fire Ring Block Layer:** adds layers to increase height



Kits are not suitable for commercial installations.





# GRAND ISLAND BAR SERIES KITS

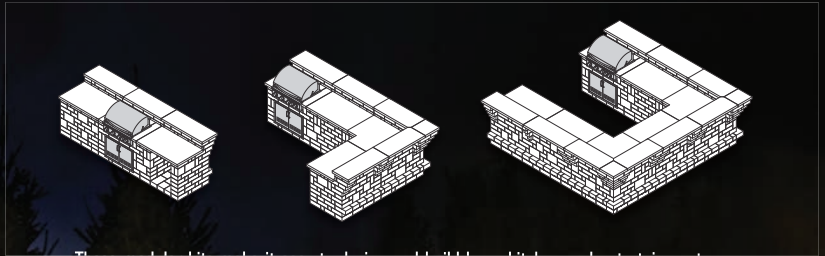

These modular kits make it easy to design and build large kitchen and entertainment areas.



Includes Summerset Pro Sizzler 32" NG or LP grill.  
Single door with grill shown no longer available.

For outdoor living enthusiasts who love cooking and entertaining, the **Grand Island Bar/Grill Series** is a wonderful addition to your home's backyard.

**a) Grand Island Bar/Grill w Storage Kit:**  
- Summerset Sizzler Pro 32" grill  
- Stainless steel double doors

**b) Grand Island Bar/Grill w Refrigerator Opening Kit:**  
- Summerset Sizzler Pro 32" grill  
- Stainless steel double doors

**c) Grand Island Bar 8' Kit**

**d) Grill Surround Kit:**  
- For standing grills, 60" opening

**e) Corner Return Kit:**  
- Makes L-shaped bar/grill

**f) Bar Section 4' Kit:**  
- Left or right facing

Grand Island Bar Series tops are 2.25" H reproductions of Indiana Limestone originals.

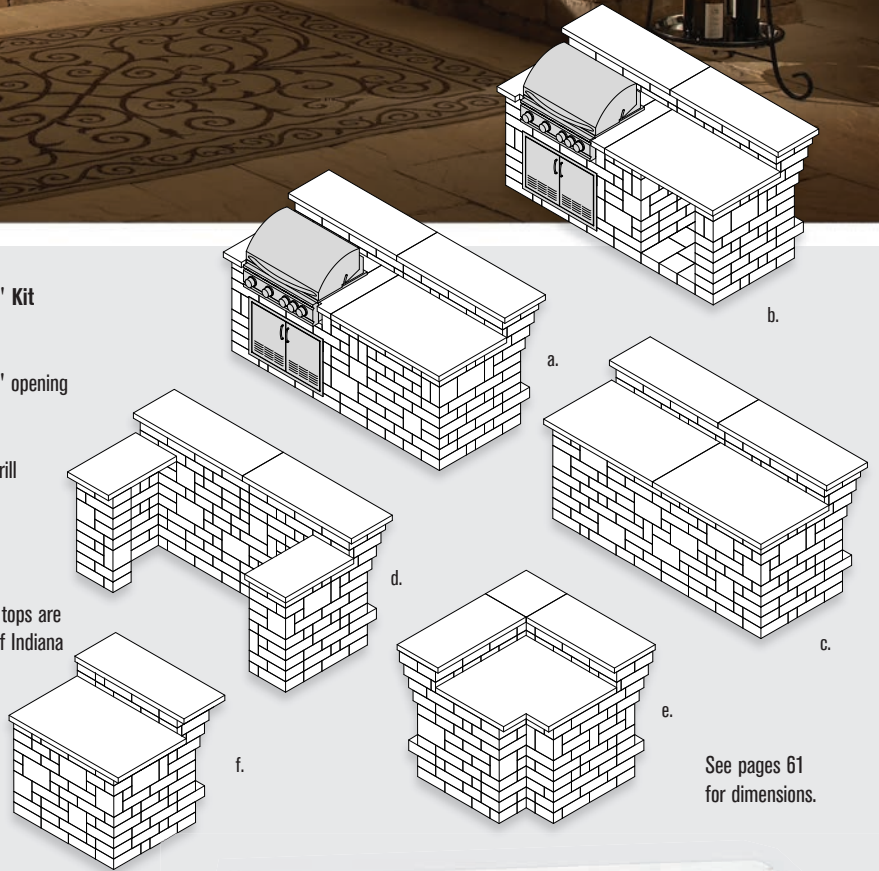

See pages 61 for dimensions.

 **SUMMERSET**

[www.summersetgrills.com](http://www.summersetgrills.com)

**Summerset Pro Sizzler Grills:**  
- #443 stainless steel construction  
- Push-to-turn knob ignition, 3" temp gauge  
- 14,000 Btu cast burners  
- 15,000 Btu infrared back burner  
- Natural gas or propane fuel  
- Double-lined hood ensures optimal airflow  
- 8mm cooking grates won't warp or rust  
- Easy-clean briquette system for even heat

- LED lit controls  
- Heat zone separators  
- Interior cooking lights  
- Requires 120 volt electrical

**Optional Deluxe Rotisserie:**  
- #304 stainless steel  
- Heavy-duty motor  
- 25 lb. capacity







## PUB/BISTRO TABLE KIT

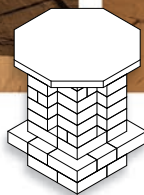
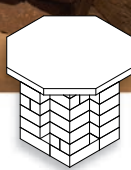

Every outdoor dining and living room should include functional and attractive furniture. These stylish Pub and Bistro Tables are the perfect size for enjoying a cold drink and summertime snacks. The hand-chiseled 36" octagon top adds a distinctive look to any outdoor area.

**Pub/Bistro Table Kit:**  
 - 42" height (Bistro 30" height)  
 - 4" foot rail



## COMPACT BAR KIT

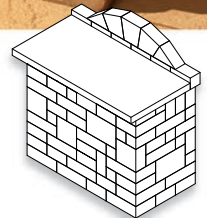
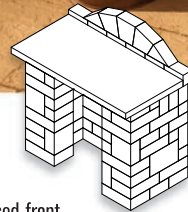

**Compact Bar Kit:**  
 - Builds open or closed front  
 - 24" D x 48" W work surface  
 - Decorative backsplash



## DINING TABLE KIT



The **Necessaries Dining Table** is easy to maintain, will never blow away in a storm and will outlast all others. The **Necessaries** table fits easily into any outdoor dining room design.

- 36" W x 96" D (top)  
 - 30" tall, dining chair height  
 - Seats eight easily





## SEATWALL KITS



Shown with optional chiseled top.



## PILLAR KITS

Waterfall kits are easy to build and essentially maintenance-free. These above-ground designs are ideal when in-ground ponds and waterfalls are not an option. Waterfall kits include all plumbing/connections. 120 volt electrical required. Catch basin stones not included.

### Grand Waterfall Kit:

- 1,350 gph mag drive pump
- 48" half-round basin
- 23" stainless steel spillway
- Optional LED light kit

### Compact Waterfall Kit:

- 850 gph mag drive pump
- 26" square basin
- 11" stainless steel spillway
- Optional LED light kit



## COMPACT WATERFALL KIT



## GRAND WATERFALL KIT

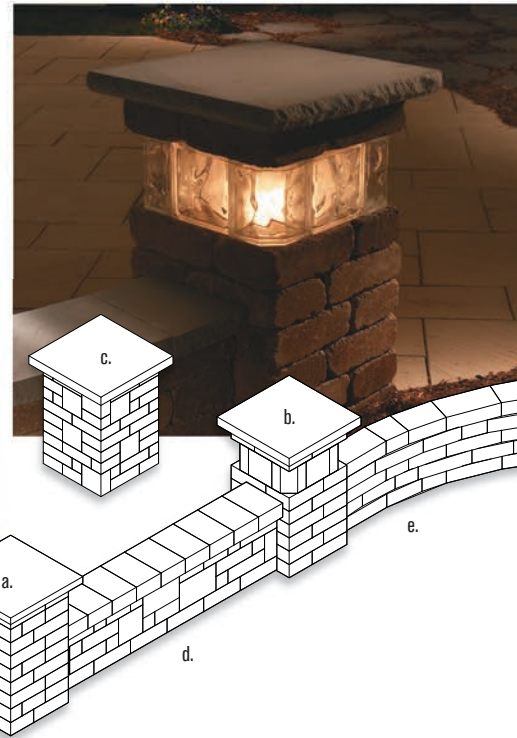

Pillars can be added to Seatwalls or built as a freestanding landscape feature, such as a property marker or light base.

### a) 20" Pillar Kit:

- 2.25" H chiseled cap

### b) 20" Pillar with Glass Kit:

- Pittsburgh Corning Premiere 8" glass block (lights not included or available)
- 2.25" H chiseled cap

### c) 24" Pillar Kit:

- 2.25" H chiseled cap

### d) Lakeland Seatwall Kit:

- Creates a 6' straight wall
- Optional chiseled cap

### e) Riverland Seatwall Kit:

- Creates an 8' radius wall
- Optional chiseled cap



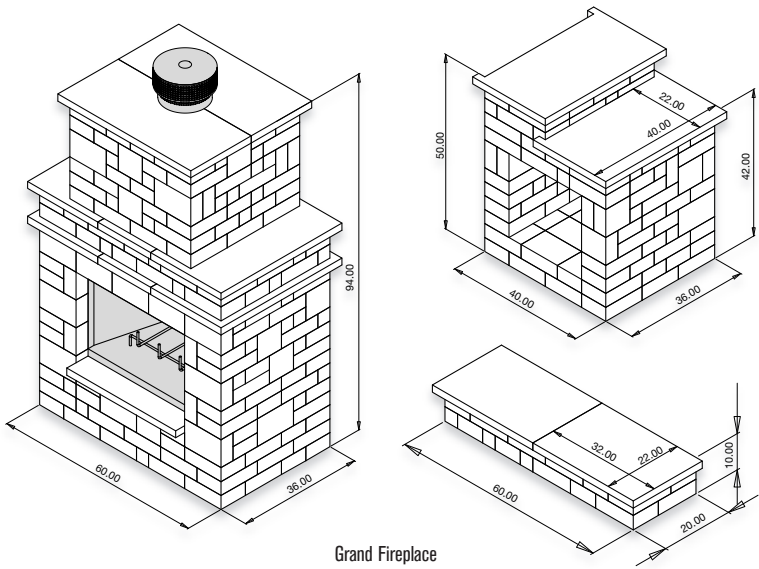

Grand Fireplace

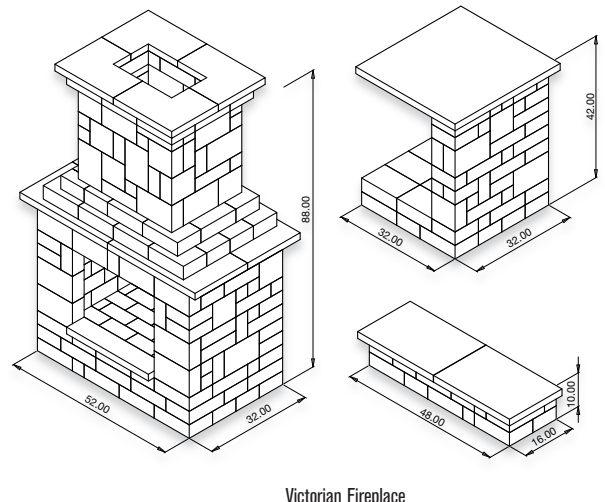

Victorian Fireplace

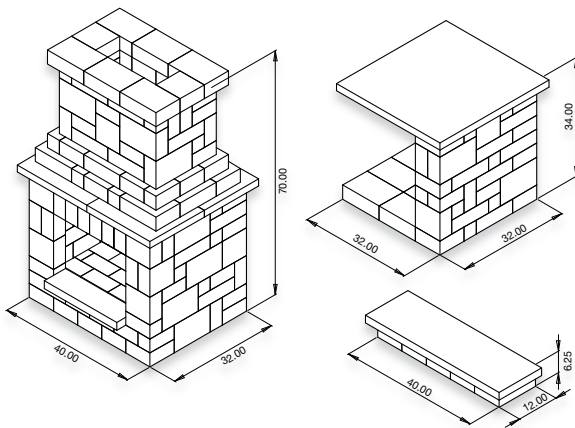

Colonial Fireplace

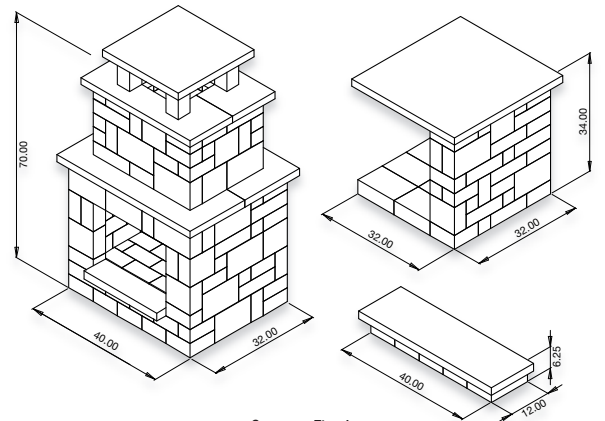

Compact Fireplace

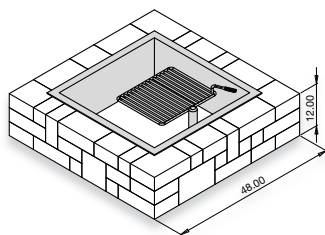

Victorian Fire Pit  
Optional cooking grate

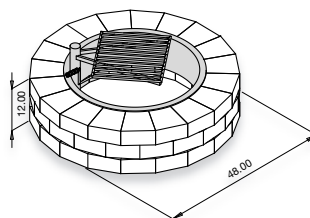

Grand Fire Ring  
Optional cooking grate

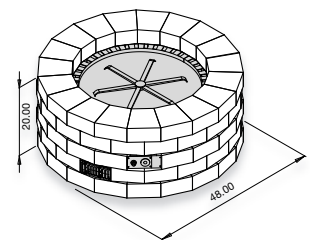

Grand Gas Fire Ring



All dimensions shown in inches. Kits are not suitable for commercial installations.

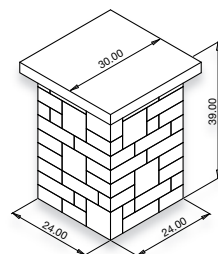

24" Pillar w/Glass

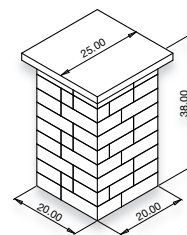

20" Pillar

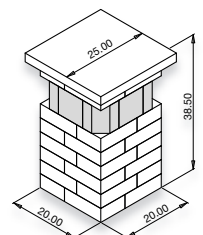

20" Pillar w/Glass



# OUTDOOR LIVING KITS



SUMMERSET

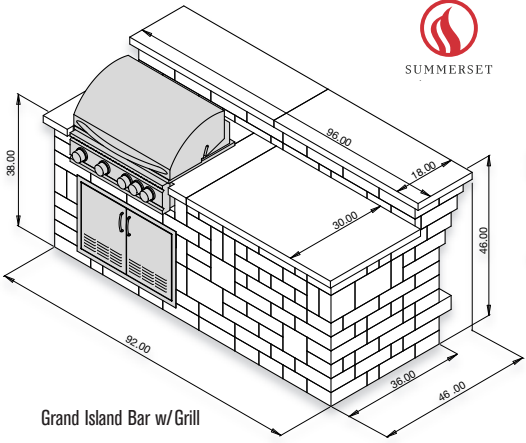

Grand Island Bar w/Grill

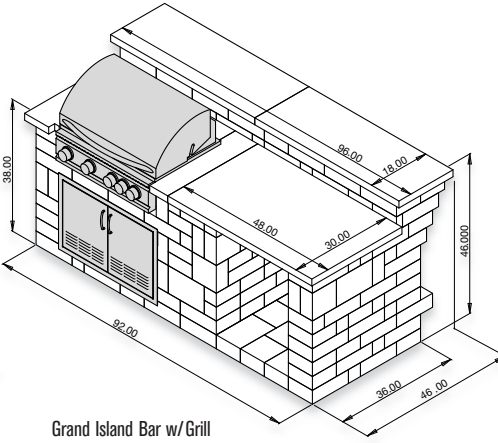

Grand Island Bar w/Grill & Refrigerator Opening

Corner Return

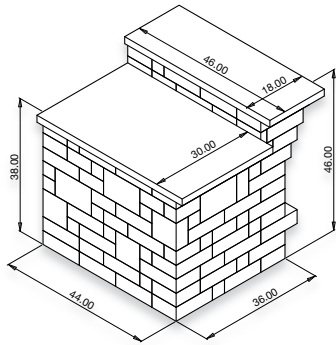
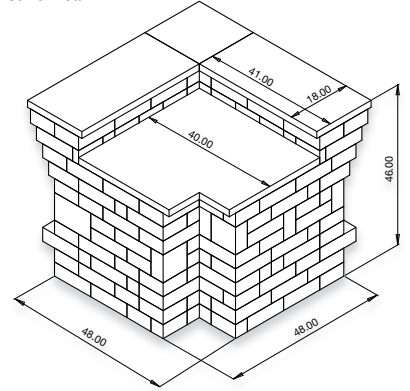

4' Bar Extension

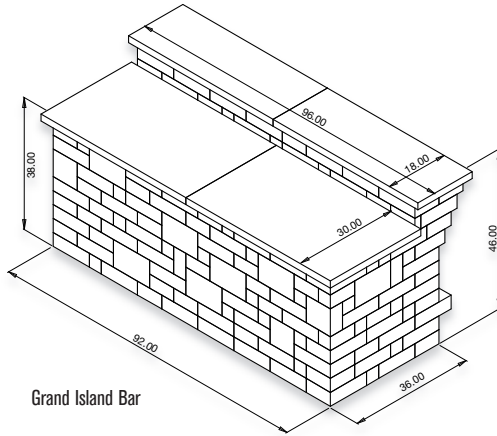

Grand Island Bar

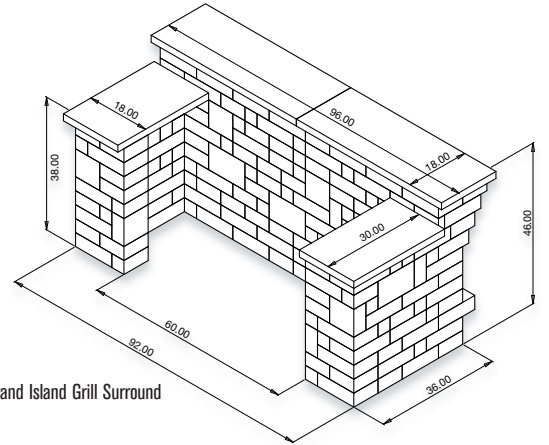

Grand Island Grill Surround

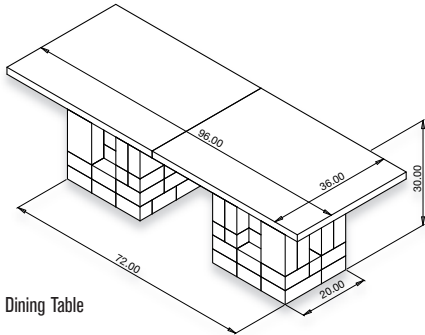

Dining Table

Compact Bar

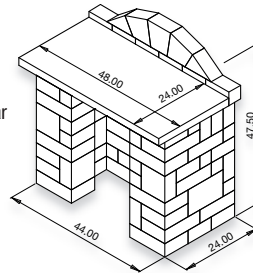

Woodbox/Stand

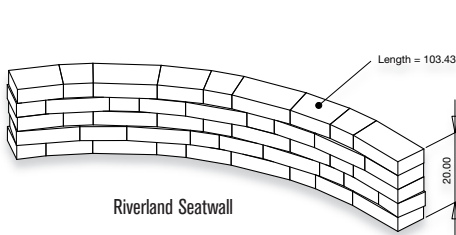
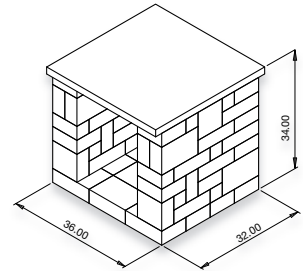

Riverland Seatwall

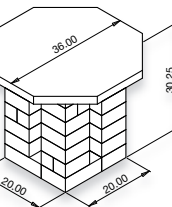
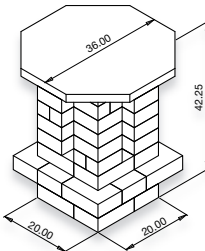

Pub/Bistro Table

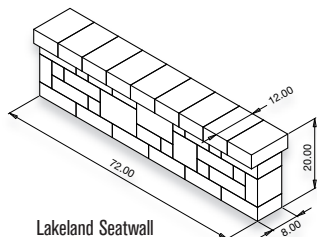

Lakeland Seatwall

Compact Waterfall

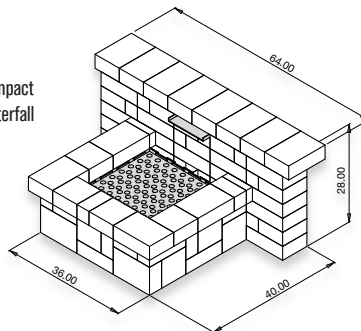

Grand Waterfall

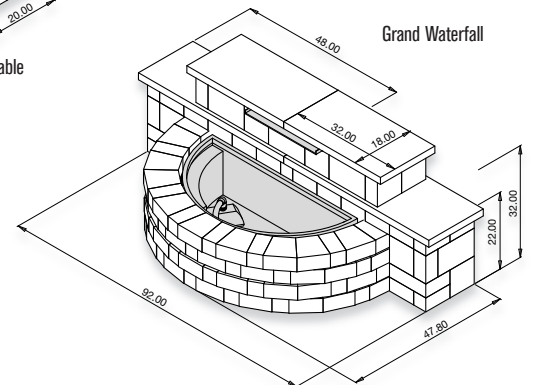



# KITCHEN

# CABINET COLLECTION



KITCHEN CABINETS ARE FOR BACKYARD BAKING, GRILLING, DINING AND ENTERTAINING. ELEGANT, FUNCTIONAL AND AFFORDABLE, THESE HIGH QUALITY KITS & COMPONENTS ARE READY TO ASSEMBLE IN ANY CONFIGURATION YOU CAN IMAGINE.



**Kitchen cabinet kits with solid granite tops:**  
 Nearly as durable as diamonds, granite owes its density and hardness to its origins – solidified under extreme pressure deep within the earth. Granite is as durable as it is beautiful; it's not affected by extremes in temperature and under normal conditions, resists etching by knives, household acids and kitchenware. Choose from two granite top colors.

**Besides its beauty, granite is:**  
 - Sanitary; when sealed, granite does not harbor bacteria  
 - Highly resistant to burning or charring from hot pans, appliances, utensils etc.  
 - 100% natural, non-toxic and easy to clean

**Earthy cabinet colors:**  
 Necessaries kits feature Rockwood Retaining Walls' multi-piece, tumbled Lakeland wall block. Its linear design and aged appearance fit well in landscapes of any style or decor. Choose from three cabinet colors.



**Kitchen kits can be ordered with or without tops.**

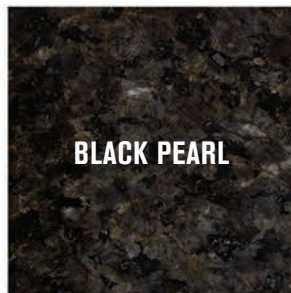



## OUTDOOR LIVING KITS

### SIZZLER PRO GRILL CABINETS



#### 32" Sizzler Pro Grill Cabinet:

- 48" W x 28" D x 37" H
- 4 main burners, 795 sq. in. cooking surface
- 56,000 max Btu's

#### 40" Sizzler Pro Grill Cabinet:

- 56" W x 28" D x 37" H
- 5 main burners, 985 sq. in. cooking surface
- 70,000 max Btu's

#### Summerset Sizzler Pro Grills:

- #443 stainless steel construction
- Push-to-turn knob ignition
- 3" temp gauge
- 14,000 Btu cast burners
- 15,000 Btu infrared back burner
- Natural gas or propane fuel
- Double-lined hood for optimal heating
- 8mm cooking grates won't warp or rust
- Easy-clean briquette system for even heat
- Exterior LED lights (120 volt electrical required)
- Heat zone separators
- Interior cooking lights
- Includes 30" double stainless doors, choice of granite/cabinet colors

#### Deluxe Rotisserie: (optional)

- #304 stainless steel
- Heavy-duty motor, 25 lb. capacity

### WOODBOK/STAND CABINET



#### Woodbox Stand Kit: (oven not available)

- 16 W x 16 D x 32" H opening (4.75 cu. ft.)
- Choice of granite/cabinet colors

 SUMMERSET

[www.summersetgrills.com](http://www.summersetgrills.com)



The **Island Cabinet Kit** is the centerpiece of your outdoor kitchen. Large enough to seat six adults, with over 28 sq. ft. of surface for prep, dining and entertaining.

- Two easy-glide stainless steel drawers and magnetic-close door
- Choice of granite and cabinet color

**Drop-in Sink: (optional)**

- 15" L x 15" W x 6" D stainless steel
- Double-handle valve stainless faucet
- Stopper/strainer

**Prep Center Cabinet Kit:**

With over 9 sq. ft. of surface, the Prep Center Cabinet will be appreciated for its generous workspace. Build it with the optional sink, and it will make your outdoor kitchen truly complete.

- Two easy-glide stainless steel drawers and magnetic close door
- Choice of granite/cabinet colors

**Drop-in Sink: (optional)**

- 15" L x 15" W x 6" D stainless steel
- Double-handle valve stainless faucet
- Stopper/strainer



# ISLAND TABLE



## REFRIGERATOR CABINET

**Refrigerator Cabinet Kit:**

- 24" W x 24" D x 36" H opening
- Choice of granite and cabinet color
- Refrigerator not available

Kits are not suitable for commercial installations.



## PREP CENTER CABINET



**Smoker Cabinet Kit:** (smoker not available)  
 - 24" W x 24" D opening for your smoker

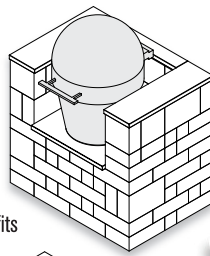

**Side Burner Cabinet Kit:**

Combine the comfort of an indoor kitchen range with all the benefits of being outside. Specially designed for performance and function, Summerset's double side burner is the perfect addition to your outdoor kitchen.

- #304 stainless steel construction
- Push-to-turn knob ignition
- 30,000 Btu/hr solid brass burners
- 19.5" x 10.5" cooking surface with stainless cover
- Two easy-glide drawers, fully enclosed exterior

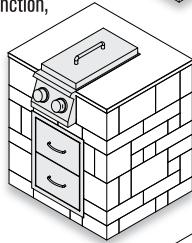

**Trash Drawer Cabinet Kit:**

- #304 stainless steel construction
- Easy-glide pullout drawer, holds 12-gallon trash can

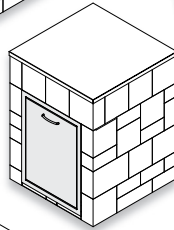

**Storage Cabinet Kit:**

- #304 stainless steel construction
- Two easy-glide drawers, fully enclosed exterior

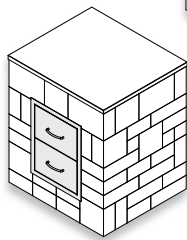

**Corner Cabinet Kit:**

- For L-shaped designs or additional space

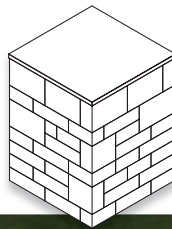

**The Kitchen Standard Features:**

- Easy-to-read, step-by-step assembly instructions
- Multi-piece Lakeland blocks in three color choices
- Solid granite tops in two color choices
- Reinforcements and concrete cut to fit
- VOC-compliant adhesive
- Protective gloves



**SMOKER CABINET**



**SIDE BURNER CABINET**



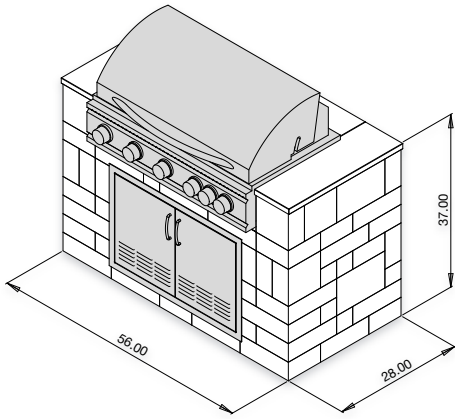

40" Sizzler Grill Cabinet

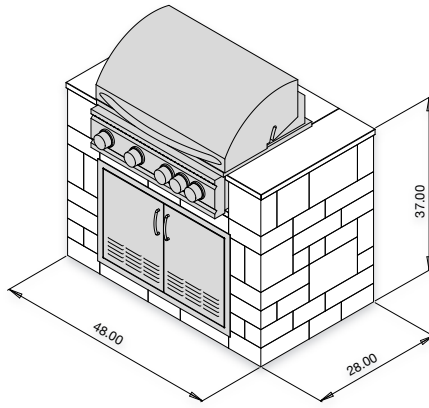

32" Sizzler Grill Cabinet

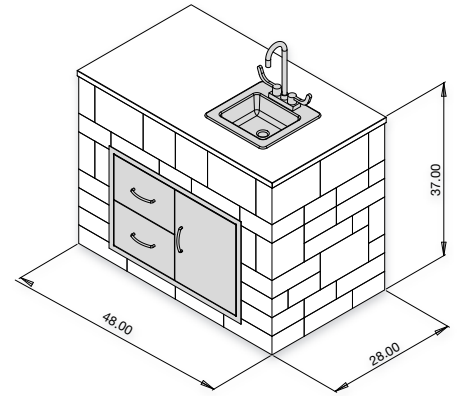

Prep Station Cabinet  
Optional sink

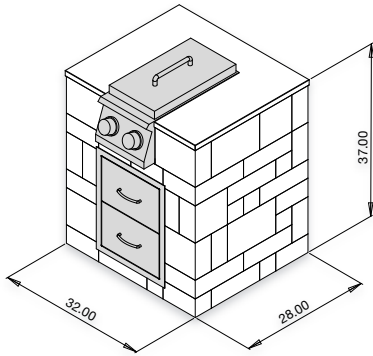

Side Burner Cabinet

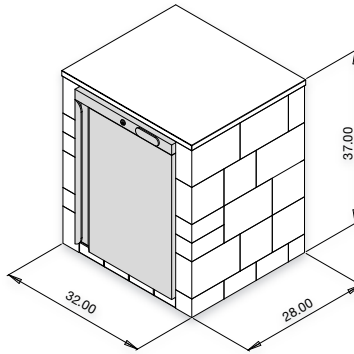

Refrigerator Cabinet

Smoker Cabinet  
Smoker not available

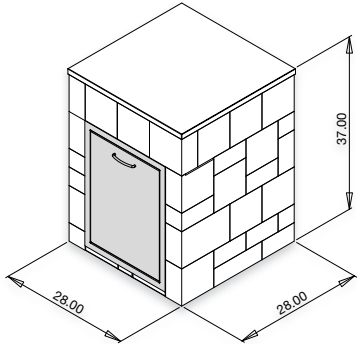
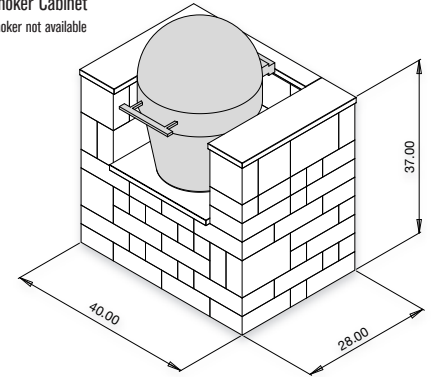

Trash Cabinet

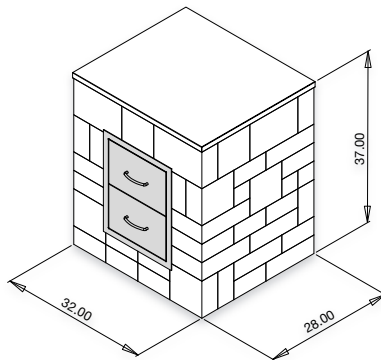

Two Drawer Cabinet

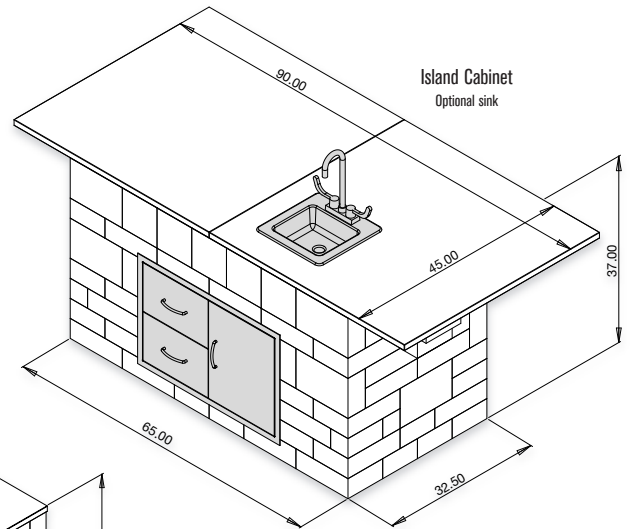

Island Cabinet  
Optional sink

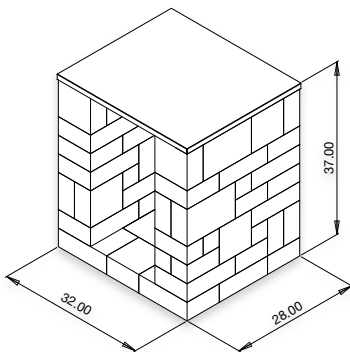

Woodbox/Stand Cabinet

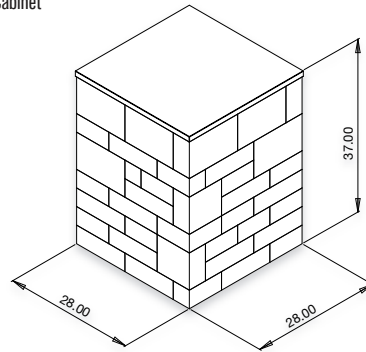

Corner Cabinet

No cutting, no guessing, no hassles - no problem!  
*necessories*  
 kits for outdoor living

**ROCKWOOD**  
 RETAINING WALLS  
 A better way.



## PROFESSIONAL GRADE SANDS, CLEANERS AND SEALERS HELP MAINTAIN YOUR PATIO, PATHWAY OR DRIVEWAYS BEAUTY INDEFINITELY.



### CHOOSE A JOINT SAND THAT STANDS UP TO THE DAMAGING EFFECTS OF FREEZE-THAW, EROSION, WEEDS AND INSECTS.

#### Choose the right joint sand the first time

Your paver project represents an investment in your home and the time you spend outdoors. Choose a high-quality polymeric joint sand to protect your investment and minimize your time spent on maintenance. Unlike conventional sands, polymeric sand remains in place, resisting erosion caused by repeated sweeping, wind, rain and even power washing.

#### Eliminate grass and weeds

Weeds and grasses will take root anywhere they can, including your new patio if not sanded properly. Polymeric sand creates an impenetrable sand joint and represents the best defense available against unwanted vegetation.

#### Insect protection

Without the proper protection, ants will take up residence in the spaces between pavers. Like weed prevention, polymeric sand forms an impenetrable barrier against ant and insect tunneling.

### LIKE ANY DECORATIVE EXTERIOR SURFACE, PAVERS AND LANDSCAPE TILES AREN'T IMMUNE TO THE EFFECTS OF TIME AND USE.

#### Keep your investment clean and beautiful

BBQ grease, motor oil, suntan lotion, fertilizer granules, bird droppings, leaf stains, paint and tire marks conspire to dull the beauty of decorative pavement. Sealing products are the optimal prevention against discoloration caused by weathering, UV rays and salt. Over time, the corrosive forces of nature can take a toll on pavers. Applying a protectant slows the march of time.

#### Make surfaces easier to clean

The time and effort required for regular cleaning or preparing to entertain is dramatically reduced if your pavement is protected. Sealers are the ultimate protection against oil and other stains.

#### Choose your look

You can choose the look of your patio, path or drive by the product used to protect its surface. A wet-look or semi-gloss sealer enhances color while matte or natural-look sealers preserve its original appearance. No matter what look you choose, sealing is the essential final step in your project.



©Copyright 2021 All Rights Reserved. Rockwood products are made under license from Rockwood Retaining Walls, Inc. US and international patents issued and pending. This information has been prepared for the benefit of customers interested in hardscaping products. It was reviewed carefully prior to publication. Mid-Atlantic Concrete Products assumes no liability for its accuracy or completeness. Final determination of the suitability of any information or material for the use contemplated, or for its manner of use, is the sole responsibility of the user. PROPOSITION 65 WARNING: These Products, the fuel used in this Products and other wood and charcoal burning appliances, and the combustion products of such fuels contain chemicals known to the State of California to cause cancer, or birth defects or other reproductive harm. 321



[www.midatlanticcp.com](http://www.midatlanticcp.com)



# WELCOME TO THE BACKYARD...



YOU'RE GOING TO LOVE IT OUT HERE!



**Mid-Atlantic**<sup>™</sup>  
CONCRETE PRODUCTS

2460 Armstrong Dr., Winston-Salem, NC 27103 • Phone: 336-774-6544 • Fax: 336-774-9060

